

# John Gardener



**Ogród**

Outdoor & Gardening





# John Gardener



John Gardener oferuje rozwiązania niezbędne do pielęgnacji ogrodów, działek oraz roślin. Misją marki jest pomoc w stworzeniu równie użytkowej, co satysfakcjonującej estetycznie przestrzeni.

Produkty marki JG charakteryzują się trwałością oraz prostotą montażu.

John Gardener troszczy się również o psychiczny komfort klienta, więc każdy z artykułów wykazuje się odpowiednią mocą, ale i możliwie jak największym wyciszeniem silnika.

JG to między innymi kosiarki, narzędzia spalinowe oraz elektryczne wykorzystywane w ogrodnictwie.

Produkty są przeznaczone zarówno dla profesjonalistów jak i amatorów.

John Gardener offers solutions necessary for the care of gardens, plots and plants. The mission of the brand is to help in creating a space that is both functional and aesthetically satisfying. JG products are characterized by durability and ease of assembly. John Gardener also cares about the psychological comfort of the customer, so each of the articles has the appropriate power, but also the greatest possible muting of the engine. JG includes, among others, lawn mowers, gasoline and electric tools used in gardening. Products are intended for both professionals and amateurs.

## O firmie

Firma GEKO jest firmą rodzinną o 100% polskim kapitale, działającą nieprzerwanie od początku lat 90 w Kietlinie obok Radomska w województwie Łódzkim.

Nasza firma jest oparta na tradycyjnych wartościach, której głównym celem jest dostarczanie klientom jak najlepszych i najnowocześniejszych rozwiązań.

Priorytetem jest jakość i trwałość produktu oraz pełna satysfakcja klienta, który po zakupie i użytkowaniu produktów naszych marek jest dodatkowo zadowolony, że wybrał rozwiązanie w korzystnej cenie.

## About us

GEKO is a family-owned company with 100% Polish capital, operating continuously since the early 90s in Kietlin near Radomsko in the Łódź province.

Our company is based on traditional values, whose main goal is to provide customers with the best and most modern solutions.

The priority is the quality and durability of the product and the full satisfaction of the customer, who after purchasing and using the products of our brands is additionally satisfied that he chose a solution at a favorable price.



John Gardener

GEKO

Tvardy

keltin



## Spis treści / Contents:

1. Kosiarki spalinowe / Lawn Mowers .....	2
2. Kosiarki elektryczne / Electric Lawn Mowers .....	5
3. Podkaszarki spalinowe / Petrol Brush Cutters .....	6
4. Podkaszarki elektryczne / Electric brush cutter .....	7
5. Części zamienne do podkaszarek / Brush Cutter Spare Parts .....	8
6. Osprzęt do podkaszarek / Brush Cutter Accessories .....	13
7. Aeratory i wertykulatory / Aerators .....	19
8. Glebogryzarki / Cultivators .....	20
9. Dmuchawy/odkurzacze ogrodowe / Leaf Blowers & Garden Vacuums .....	22
10. Piły, pilarki / Chain Saws .....	23
11. Nożyce do żywopłotu, trawy i krzewów / Hedge, grass and shrub shears .....	31
12. Przycinanie i cięcie / Pruning & Cutting .....	33
13. Rozdrabniacze do gałęzi/siewniki / Garden Shredders/Seeders .....	42
14. Opryskiwacze ogrodowe / Sprayers .....	43
15. Pompy do wody / Water Pumps .....	49
16. Wężę i akcesoria ogrodowe / Garden Hoses and accessories .....	61
17. Wężę strażackie / Fire Hoses .....	68
18. Plandeki / Tarpaulins .....	72
19. Wiertnice do gleby / Augers .....	77
20. Łopaty, szpadle, widły i grabie / Shovels, spades, forks and rakes .....	79
21. Łopaty do śniegu / Snow Shovels .....	84
22. Miotły i szczotki / Brooms & Brushes .....	86
23. Rękawice / Gloves .....	87
24. Wałki przekaźnika mocy / PTO Shafts .....	90
25. Koła, dętki, opony / Wheels, tubes, tires .....	92
26. Silniki elektryczne / Electric Engines .....	96
27. Silniki spalinowe / Gas Engines .....	97
28. Oleje / Oils.....	99
29. Kanistry / Petrol Cans .....	100
30. Grille / Grills.....	102
31. Pozostałe / Other Garden Tools .....	103
32. Oświetlenie / Lighting .....	105
33. Myjki ciśnieniowe i akcesoria / Pressure Washers and accessories.....	106
34. Sprzęt i akcesoria turystyczne / Tourist Equipment & Accessories .....	110





# Kosiarki spalinowe / Lawn Mowers





<b>99cc</b>	moc nominalna 1.6kw
20/40/60mm	400mm
15 cm 15	45 l
<b>OHV</b>	



GB Lawn mower  
DE Rasenmäher  
RU Газонокосилки  
CZ Sekačka na trávu  
SK Kosačka na trávu  
HU Fűnyíró  
RO Mașină de tuns iarba

Kod EAN  
5901477129438

John Gardener Kod produktu **#Kosiarka spalinowa 40cm /metal obudowa/ JG G83050 1**

<b>173cc</b>	moc nominalna 3.6kw
25-70mm	510mm
25 cm 20,5	60 l
<b>OHV</b>	



GB Lawn mower  
DE Rasenmäher  
RU Газонокосилки  
CZ Sekačka na trávu  
SK Kosačka na trávu  
HU Fűnyíró  
RO Mașină de tuns iarba

Kod EAN  
5901477129414

John Gardener Kod produktu **#Kosiarka spalinowa JG z napędem 51cm 6w1 G83051 1**

<b>196cc</b>	moc nominalna 3.6kw
25-70mm	510mm
25 cm 20,5	60 l
<b>OHV</b>	system mycia obudowy



GB Lawn mower  
DE Rasenmäher  
RU Газонокосилки  
CZ Sekačka na trávu  
SK Kosačka na trávu  
HU Fűnyíró  
RO Mașină de tuns iarba

Kod EAN  
5901477129421

John Gardener Kod produktu **#Kosiarka spalinowa z napędem i elek. startem 51cm G83052 1**

<b>196cc</b>	moc nominalna 3.6kw
25-70mm	510mm
29,5 cm 20,5	60 l
system mycia obudowy	<b>LONCIN</b>



GB Lawn mower  
DE Rasenmäher  
RU Газонокосилки  
CZ Sekačka na trávu  
SK Kosačka na trávu  
HU Fűnyíró  
RO Mașină de tuns iarba

Kod EAN  
5901477129384

John Gardener Kod produktu **#Kosiarka spalinowa z napędem 51cm G83053 1**

<b>196cc</b>	moc nominalna 3.6kw
25-70mm	510mm
29,5 cm 20,5	60 l
system mycia obudowy	<b>LONCIN</b>



GB Lawn mower  
DE Rasenmäher  
RU Газонокосилки  
CZ Sekačka na trávu  
SK Kosačka na trávu  
HU Fűnyíró  
RO Mașină de tuns iarba

Kod EAN  
5901477129391

John Gardener Kod produktu **#Kosiarka spalinowa z napędem i elek. startem 51cm G83054 1**

<b>139cc</b>	moc nominalna 2.7kw
25-75mm	400mm
20 cm 15	40 l
<b>OHV</b>	





GB Lawn mower  
DE Rasenmäher  
RU Газонокосилки  
CZ Sekačka na trávu  
SK Kosačka na trávu  
HU Fűnyíró  
RO Mașină de tuns iarba



Kod EAN  
5901477139239

John Gardener Kod produktu **#Kosiarka spalinowa 40cm /metal obud./ z napędem G83055 1**



139cc  2.7kw

 25-75mm  460mm

 17,5 cm 25"  60 l

OHV



GB Lawn mower  
DE Rasenmäher  
RU Газонокосилки  
CZ Sekačka na trávu  
SK Kosačka na trávu  
HU Fűnyíró  
RO Mașină de tuns iarba



John Gardener Kod produktu  #Kosiarka spalinowa z napędem 46cm G83056 1

140cc  2.1kw

 25-70mm  510mm

 17,5 cm 25"  60 l

system mycia obudowy



GB Lawn mower  
DE Rasenmäher  
RU Газонокосилки  
CZ Sekačka na trávu  
SK Kosačka na trávu  
HU Fűnyíró  
RO Mașină de tuns iarba



John Gardener Kod produktu  #Kosiarka spalinowa do trawy JG 51cm Multi B&S G83059 1

**silnik 500E Series™**

- Silnik górnozaworowy
- Tłumik Lo-Tone™
- Technologia OHV
- Większy moment obrotowy
- Gaźnik pływakowy
- Filtr powietrza z gąbki naoliwionej
- Smarowanie rozbryzgowe
- Przewody paliwa o niskim przenikaniu



**140** **6,78**  
cm<sup>3</sup> Nm



**EURO 5**



# Kosiarki elektryczne / Electric Lawn Mowers



230V~50Hz	pobór prądu 1200W
25/40/55mm	320mm
3000obr/min	35 l



230V~50Hz	pobór prądu 1200W
25/60mm	320mm
3100obr/min	30 l



GB Electric lawn mower  
DE Elektrischer Rasenmäher  
RU Электрическая газонокосилка  
CZ Elektrické sekačky na trávu  
SK Elektrická sekačka na trávu  
HU Elektromos fűnyíró  
RO Mașină de tuns gazon electric



Kod EAN  
5901477156205  
Kod produktu  
G83025 1

John Gardener  
Kosiarka elektryczna indukcyjna 32cm

GB Electric lawn mower  
DE Elektrischer Rasenmäher  
RU Электрическая газонокосилка  
CZ Elektrické sekačky na trávu  
SK Elektrická sekačka na trávu  
HU Elektromos fűnyíró  
RO Mașină de tuns gazon electric



Kod EAN  
5901477156212  
Kod produktu  
G83026 1

John Gardener  
Kosiarka elektryczna 32cm model: SHARP

230V~50Hz	pobór prądu 1300W
25/60mm	320mm
3100obr/min	30 l



230V~50Hz	pobór prądu 1700W
25/75mm	380mm
3450obr/min	40 l



GB Electric lawn mower  
DE Elektrischer Rasenmäher  
RU Электрическая газонокосилка  
CZ Elektrické sekačky na trávu  
SK Elektrická sekačka na trávu  
HU Elektromos fűnyíró  
RO Mașină de tuns gazon electric



Kod EAN  
5901477156229  
Kod produktu  
G83027 1

John Gardener  
Kosiarka elektryczna 32cm model: HD EXTREME

GB Electric lawn mower  
DE Elektrischer Rasenmäher  
RU Электрическая газонокосилка  
CZ Elektrické sekačky na trávu  
SK Elektrická sekačka na trávu  
HU Elektromos fűnyíró  
RO Mașină de tuns gazon electric



Kod EAN  
5901477161421  
Kod produktu  
G83028 1

John Gardener  
Kosiarka elektryczna 38cm reg. wys. model: STRONG



# Podkaszarki spalinowe / Petrol Brush Cutters



<b>52cc</b>	8000obr/min
255mm	425mm
25 : 1	1000ml



GB Gasoline brush cutter  
DE Benzin freischneider  
RU Бензиновый триммер  
CZ Křovinořez  
SK Krovinořez  
HU Benzines bozótívágó  
RO Motocoasa benzina



Kod EAN  
5901477130038  
Kod produktu  
G81057 1

John Gardener Podkaszarka spalinowa multifunkcyjna 4w1 G81057 1



<b>52cc</b>	1.6kW
255mm	425mm
25 : 1	850ml
7000obr/min	



GB Gasoline brush cutter  
DE Benzin freischneider  
RU Бензиновый триммер  
CZ Křovinořez  
SK Krovinořez  
HU Benzines bozótívágó  
RO Motocoasa benzina



Kod EAN  
5901477123368  
Kod produktu  
G81059 1

John Gardener Podkaszarka spalinowa antywibracyjna 52cc G81059 1



<b>42,7cc</b>	1.3kW
255mm	410mm
25 : 1	1000ml
8000obr/min	



GB Gasoline brush cutter  
DE Benzin freischneider  
RU Бензиновый триммер  
CZ Křovinořez  
SK Krovinořez  
HU Benzines bozótívágó  
RO Motocoasa benzina



Kod EAN  
5901477121074  
Kod produktu  
G81061 1

John Gardener Podkaszarka spalinowa z dodatkowym wyposażeniem G81061 1



<b>49,7cc</b>	1.3kW
255mm	425mm
25 : 1	1000ml
8000obr/min	



GB Gasoline brush cutter  
DE Benzin freischneider  
RU Бензиновый триммер  
CZ Křovinořez  
SK Krovinořez  
HU Benzines bozótívágó  
RO Motocoasa benzina



Kod EAN  
5901477116742  
Kod produktu  
G81062 1

John Gardener Podkaszarka spalinowa GAZELA G81062 1



# Podkaszarki elektryczne / Electric brush cutter

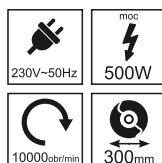
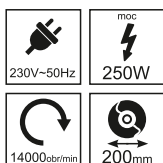

GB Electric trimmer  
DE Elektro-Rasentrimmer  
RU Электрический триммер  
CZ Elektrická sekačka  
SK Elektrická kosačka  
HU Elektromos fűnyíró  
RO Cositoare electrică



John Gardener  
Podkaszarka elektryczna do trawy G83015 20

GB Electric trimmer  
DE Elektro-Rasentrimmer  
RU Электрический триммер  
CZ Elektrická sekačka  
SK Elektrická kosačka  
HU Elektromos fűnyíró  
RO Cositoare electrică



John Gardener  
Podkaszarka elektryczna do trawy PROFI G83016 4



GB Nylon cutter  
DE Trimmerkopf  
RU Головка триммерная  
CZ Strunová hlava  
SK Strunová hlava  
HU Damil fej  
RO Cap cu cablu



John Gardener  
Głowica żyłkowa do kosi elektrycznej G83015 250W CG83015-1 300



GB Nylon cutter  
DE Trimmerkopf  
RU Головка триммерная  
CZ Strunová hlava  
SK Strunová hlava  
HU Damil fej  
RO Cap cu cablu



John Gardener  
Głowica żyłkowa do kosi elektrycznej G83016 500W CG83016-1 100



# Części zamienne do podkaszarek / Brush Cutter Spare Parts



43cc  
8000obr/min

25 : 1  
1200ml



GB Engine for gasoline brush cutter  
DE Motor für Benzin Freischneider  
RU Двигатель для бензиновый триммер  
CZ Motor k benzínovému křovinořezu  
SK Motor k benzínovému křovinořezu  
HU Motor benzines bozótvágozóhoz  
RO Motor pentru motocosiitoare pe benzina

John Gardener  
Silnik do podkaszarki spalinowej  
Kod produktu  
G81064 4

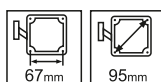

GB Starter  
DE Starter  
RU Craprep  
CZ Startování  
SK Štartovanie  
HU Indító  
RO Demaror

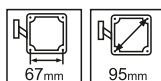

John Gardener  
Starter do podkaszarki  
Kod EAN  
5901477123894  
Kod produktu  
G81065A 100



GB Starter  
DE Starter  
RU Craprep  
CZ Startování  
SK Štartovanie  
HU Indító  
RO Demaror

John Gardener  
Starter do podkaszarki no.3 ze sprężyną  
Kod EAN  
5901477136030  
Kod produktu  
G81065B 100



GB Supper strap  
DE Doppelschultergurt  
RU Ремень наплечный двойной  
CZ Dvojrámenný popruh  
SK Dvojrámenný popruh  
HU Dupla vállpánt  
RO Ham Motocoasa

Kod EAN  
5901477154096

John Gardener Kod produktu 40  
Szelki do kosy spalinowej JG PREMIUM G81065C 40



GB Element for fastening handles  
DE Griffhalter für Motorsense  
RU Кронштейн крепления руля бензокосы  
CZ Držák rúčky pro křovinořez  
SK Držák rúčky pro křovinořez  
HU Fogantyú rögzítő  
RO Element pentru mánere de fixare

Kod EAN  
5901477123900

John Gardener Kod produktu 100  
Krzyżak do mocowania rączki kosy 28mm G81065G 100



GB Knife for shield set with 3 screws  
DE Messer für Rasenmäher  
RU Нож для обрезки лески бензокосы  
CZ Nůž pro sekačku  
SK Nůž pre kosačku  
HU Fűnyíró penge  
RO Cuțit pentru mașina de tuns iarba

Kod EAN  
5901477123917

John Gardener Kod produktu 300  
Nóż odcinający żyłkę do kosy spalinowej G81065H 300



GB Part of shield set  
DE Schutzhaube für Schnitffaden  
RU Гребень на бензокосы  
CZ Ochranný kryt sečení  
SK Ochranný kryt kosenia  
HU Védőburkolat fűkaszához  
RO Cuțit pentru carcasa protectie motocoasa

Kod EAN  
5901477128547

John Gardener Kod produktu 250  
Grzebień osłony do kosy spalinowej G81065I 250



GB Cable for oil tank  
DE Schlauch für Sense  
RU Топливопровод в сборе для бензокосы  
CZ Hadice s filtrem pro křovinořez  
SK Hadica s filtrom pre křovinořez  
HU Olajtartály kábel  
RO Filtru + furtun benzina motocoasa

Kod EAN  
5901477128554

John Gardener Kod produktu 500  
Wężyk paliwa z filtrem do kosy spalinowej G81065J 500



GB Nylon cutter  
DE Trimmerkopf  
RU Головка триммерная  
CZ Strunová hlava  
SK Strunová hlava  
HU Damil fej  
RO Cap cu cablu

Kod EAN  
5901477132032

John Gardener Kod produktu 50  
Głowica żyłkowa do podkaszarki NEW G81065K 50

40T



GB 40T blade  
DE 40 Zähne Rodungssägeblatt  
RU Диск для кустореза 30зубы  
CZ Kotouč 30-zubý  
SK Kotoúč 30-zuby  
HU Vágókorong  
RO Disc Taietor

Kod EAN  
5901477123924

John Gardener Kod produktu 100  
Tarcza tnąca do podkaszarki 40-zębów G81065L 100



GB Set of gaskets  
DE Dichtungssatz für Motorsense  
RU Комплект уплотнителей для бензокосилки  
CZ Set podložek a těsnění pro křovinořez  
SK Set podložiek a tesnení pre křovinořez  
HU Tömítő készlet fűkaszához  
RO Set garnituri drujba

Kod EAN  
5901477128165

John Gardener Kod produktu 500  
Zestaw membran gaźnika do podkaszarki spalinowej G81065M 500



GB Cap for oil tank for brushcutter  
DE Tankdeckel öl tank passend  
RU Крышка масляного бака для бензопил  
CZ Paliivová nádrž čínské křovinořez  
SK Paliivová nádrž čínskej křovinořez  
HU Benzín sapka  
RO Rezervor benzina drujba

Kod EAN  
5901477119002

John Gardener Kod produktu 200  
Korek zbiornika paliwa do kosy G81065N 200



GB Set of gaskets  
DE Dichtungssatz für Motorsense  
RU Комплект уплотнителей для бензокосилки  
CZ Set podložek a těsnění pro křovinořez  
SK Set podložiek a tesnení pre křovinořez  
HU Tömítő készlet fűkaszához  
RO Set garnituri drujba

Kod EAN  
5901477123931

John Gardener Kod produktu 500  
Komplet podkładek-uszcielek do podkaszarki G81065P 500



GB Mask  
DE Kopfschutzschild  
RU Маска  
CZ Ochranná maska  
SK Ochranná maska  
HU Védőmaszk  
RO Masca protectie

Kod EAN  
5901477123948

John Gardener Kod produktu 48  
Maska ochronna z osłoną PCV do kos, pił G81065Z 48



GB Wall bracket-holder for Brushcutter  
DE Wandhalterung für Freischneider  
RU Настенный кронштейн-держатель для Brushcutter  
CZ Držák na zeď pro křovinořez  
SK Držák na stenu pre křovinořez  
HU Fall konzolltartó a bozótívágóhoz  
RO Suport pentru perete pentru decupător

Kod EAN  
5901477167195

John Gardener Kod produktu 100  
Uchwyt-wieszak na ścianę do kosy podkaszarki G81066C 100





GB Carburetor  
DE Vergaser  
RU карбюратор  
CZ Karburátor  
SK Karburátor  
HU Karburátor  
RO Carburator

Kod EAN  
5901477123955

John Gardener Kod produktu 100  
**Gaźnik do kosy spalinowej uniwersalny G81066G 100**



GB Clutch Assy  
DE die Kiefer zu der Kupplung  
RU Челюсти к муфте  
CZ Spojka pro křovinořez  
SK Spojka pre krovinořez  
HU Tengelykapcsoló fűkaszához  
RO Ambreiaj drujba

Kod EAN  
5901477127045

John Gardener Kod produktu 100  
**Szczęki do sprzęgła podkaszarki spalinowej G81066R 100**



GB Electronic ignition  
DE Zündspule für Benzin Freischneider  
RU катушка зажигания для бензиновый триммер  
CZ Indukční cívka  
SK Indukčná cievka  
HU Gyújtótekercs fűkaszához  
RO Bobina de inducție

Kod EAN  
5901477123962

John Gardener Kod produktu 100  
**Cewka zapłonowa kosy spalinowej G81066W 100**



GB Flywheel  
DE Schwungrad  
RU Маховик  
CZ Setřvačník  
SK Zotrvačník  
HU Lendkerék  
RO Volantul

Kod EAN  
5901477127052

John Gardener Kod produktu 1  
**Koło zamachowe do kosy spalinowej G81066X 1**



GB Connecting rod  
DE Pleuel  
RU Шатун  
CZ Klukový hřídel pro křovinořez  
SK Klukový hriadeľ pre krovinořez  
HU Hajtókár fűkaszához  
RO Biela

Kod EAN  
5901477127069

John Gardener Kod produktu 50  
**Korbowód do kosy spalinowej G81067G 50**



GB Spark plug  
DE Zündkerze  
RU Свеча зажигания  
CZ Zapařovací svíčka  
SK Zapařovacia sviečka  
HU Gyújtógyertya  
RO Bujii de aprindere

Kod EAN  
5901477123979

John Gardener Kod produktu 500  
**Świeca zapłonowa kosy spalinowej G81067S 500**



GB Carbureator base  
DE Vergaserunterteil  
RU Карбюраторная база  
CZ Základna karburátoru  
SK Základňa karburátora  
HU Karburátor alap  
RO Baza carburatorului

Kod EAN  
5901477128172

John Gardener Kod produktu 1  
**Podstawa gaźnika G81067X 1**



GB Starter  
DE Starter  
RU Стартёр  
CZ Startováni  
SK Štartovanie  
HU Indító  
RO Demaror

67mm 95mm

Kod EAN  
5901477149047

John Gardener Kod produktu 100  
**Starter do podkaszarki no.2 G81068A 100**



GB Piston  
DE Kolben  
RU Поршень  
CZ Píst  
SK Piest  
HU Dugattyú  
RO Piston

Kod EAN  
5901477127106

John Gardener Kod produktu 1  
**Tłok kosy spalinowej JG G81068E 1**



GB Bolt  
DE Bolzen  
RU Болт  
CZ Šroub  
SK Skrutka  
HU Csavar  
RO Bolt

Kod EAN  
5901477127113

John Gardener Kod produktu 1  
**Sworzeń tłoka kosy spalinowej G81068G 1**



GB Fuel tank  
DE Kraftstofftank  
RU Топливный бак  
CZ Palivová nádrž pro křovinořez  
SK Palivová nádrž pre krovinořez  
HU Üzemanyag tartály  
RO Combustibil motocoasa

Kod EAN  
5901477123986

John Gardener Kod produktu 50  
**Zbiornik paliwa kosy spalinowej G81068J 50**



GB Head with 7teeth mode 26mm  
DE Kegelradgetriebe 7t 26mm  
RU Угловаа головка 7 зубов 26мм  
CZ Úhlová převodovka křovinořezu  
SK Úhlová prevodovka krovinořezu  
HU Kúpogaskerék  
RO Cap trimmer

Kod EAN  
5901477127120

John Gardener Kod produktu 50  
**Przekładnia kątowna do kosy spalinowej 7frezów 26mm G81068M 50**





GB Clutch cover  
DE Kupplungsdeckel  
RU Крышка сцепления  
CZ Buben spojky pro křovinořez  
SK Buben spojky pre krovinořez  
HU Kuplungfedél  
RO Carcase ambreiaj

Kod EAN  
5901477124068

John Gardener Kod produktu 50  
**Walek napędowy do kosi spalinowej 7 frezów G81068N 50**



GB Shield set with knife  
DE Messer Schutz für Motorsense  
RU Кожух защитный для бензокос с креплением  
CZ Kryt žací hlavy pro křovinořez  
SK Kryt žacej hlavy pre krovinořez  
HU Védőburkolat fűkaszához  
RO Carcasa protectie motocoasa

Kod EAN  
5901477124211

John Gardener Kod produktu 50  
**Oslona do kosi spalinowej z nożem G81068O 50**



GB Right handlebar with controller  
DE Griff mit für die Motorsense  
RU Ручка регулятор  
CZ Rukojeť na křovinořez  
SK Rukoväť na krovinořez  
HU Fűkasza alkatrésze  
RO Controlor

Kod EAN  
5901477124228

John Gardener Kod produktu 100  
**Prawa rączka z regulatorem do kosi spalinowej G81068R 100**



GB Clutch cover  
DE Kupplungsdeckel  
RU Крышка сцепления  
CZ Buben spojky pro křovinořez  
SK Buben spojky pre krovinořez  
HU Kuplungfedél  
RO Carcase ambreiaj

Kod EAN  
5901477127168

John Gardener Kod produktu 100  
**Oslona sprzęgła (kosz) 7 zębów G81068U 100**



GB Connector  
DE Verbindungstück  
RU Верхний редуктор бензокосы  
CZ Spojkový koš pro křovinořez  
SK Spojkový koš pre krovinořez  
HU Összekötőelem  
RO Conector

Kod EAN  
5901477127175

John Gardener Kod produktu 50  
**Bęben sprzęgła(kosz)kosi spal. 7 frezów 26mm G81068W 50**



GB Supper strap  
DE Doppelschultergurt  
RU Ремень наплечный двойной  
CZ Dvojranný popruh  
SK Dvojramenný popruh  
HU Dupla vállpánt  
RO Ham Motocoasa

Kod EAN  
5901477128561

John Gardener Kod produktu 50  
**Szelki do podkaszarki typ lekki G81068X 50**



GB Starter  
DE Starter  
RU Стартер  
CZ Startování  
SK Štartovanie  
HU Indító  
RO Demaror

Kod EAN  
5901477124037

John Gardener Kod produktu 100  
**Starter do podkaszarek i opryskiwaczy spalinowych G81068Z 100**



GB Head with 9teeth mode 26mm  
DE Kegeelradgetriebe 9t 26mm  
RU Угловая головка 9 зубов 26мм  
CZ Úhlová převodovka křovinořezu  
SK Úhlová prevodovka krovinořezu  
HU Kúpfogaskerék  
RO Cap trimmer

Kod EAN  
5901477124198

John Gardener Kod produktu 50  
**Przekładnia kątowna do kosi spalinowej 9frezów 26mm G81069B 50**



GB Head with 9teeth mode 28mm  
DE Kegeelradgetriebe 9t 28mm  
RU Угловая головка 9 зубов 28мм  
CZ Úhlová převodovka křovinořezu  
SK Úhlová prevodovka krovinořezu  
HU Kúpfogaskerék  
RO Cap trimmer

Kod EAN  
5901477124204

John Gardener Kod produktu 50  
**Przekładnia kątowna do kosi spalinowej 9frezów 28mm G81069C 50**



GB Clutch cover  
DE Kupplungsdeckel  
RU Крышка сцепления  
CZ Buben spojky pro křovinořez  
SK Buben spojky pre krovinořez  
HU Kuplungfedél  
RO Carcase ambreiaj

Kod EAN  
5901477124082

John Gardener Kod produktu 100  
**Walek napędowy do kosi spalinowej 9 frezów G81069D 100**



GB Clutch cover  
DE Kupplungsdeckel  
RU Крышка сцепления  
CZ Buben spojky pro křovinořez  
SK Buben spojky pre krovinořez  
HU Kuplungfedél  
RO Carcase ambreiaj

Kod EAN  
5901477124099

John Gardener Kod produktu 50  
**Walek napędowy do kosi spalinowej-kwadrat G81069E 50**



GB Clutch cover  
DE Kupplungsdeckel  
RU Крышка сцепления  
CZ Buben spojky pro křovinořez  
SK Buben spojky pre krovinořez  
HU Kuplungfedél  
RO Carcase ambreiaj

Kod EAN  
5901477124105

John Gardener Kod produktu 100  
**Kosz sprzęgła 9 zębów G81069F 100**



GB Clutch cover  
DE Kupplungsdeckel  
RU Крышка сцепления  
CZ Buben spojky pro křovinořez  
SK Buben spojky pre křovinořez  
HU Kuplungfedél  
RO Carcase ambreiaj

Kod EAN  
5901477140129

John Gardener  
Kod produktu  
**Kosz sprzęgła kwadrat G81069G 100**



GB Connector  
DE Verbindungstück  
RU Верхний редуктор бензокосы  
CZ Spojkový koš pro křovinořez  
SK Spojkový koš pre křovinořez  
HU Összekötőelem  
RO Conector

Kod EAN  
5901477124143

John Gardener  
Kod produktu  
**Bęben sprzęgła, kosz do kosy spal. 9 frezów 28mm G81069H 50**



GB Supper strap  
DE Doppelschultergurt  
RU Ремень наплечный двойной  
CZ Dvojrámenný popruh  
SK Dvojrámenný popruh  
HU Dupla vállpánt  
RO Ham Motocoasa

Kod EAN  
5901477125676

John Gardener  
Kod produktu  
**Szelki do kosy typ ciężki G81069I 40**



GB Ear muff  
DE Gehörschutz  
RU Средства защиты слуха  
CZ Chrániče sluchu  
SK Chrániče sluchu  
HU Fülvédőt  
RO Antifoane

Kod EAN  
5901477124235

John Gardener  
Kod produktu  
**Nauszniki ochronne G81069J 50**



GB Mask  
DE Kopfschutzschild  
RU Маска  
CZ Ochranná maska  
SK Ochranná maska  
HU Védőmaszk  
RO Masca protectie

Kod EAN  
5901477124112

John Gardener  
Kod produktu  
**Maska ochronna z siatką JG do kos, pił G81069K 48**



GB Head 9 teeth 28mm Japan Type  
DE Kegelfradgetriebe 9t 28mm  
RU Угловая головка 9 зубов 28мм  
CZ Úhlová převodovka křovinořezu  
SK Úhlová prevodovka křovinořezu  
HU Kúpfogaskerék  
RO Cap trimmer

Kod EAN  
5901477127205

John Gardener  
Kod produktu  
**Przekładnia kątowna, do kosy PROFI 9 frezów 28mm G81069O 50**



GB Connector  
DE Verbindungstück  
RU Верхний редуктор бензокосы  
CZ Spojkový koš pro křovinořez  
SK Spojkový koš pre křovinořez  
HU Összekötőelem  
RO Conector

Kod EAN  
5901477124129

John Gardener  
Kod produktu  
**Bęben sprzęgła (kosz) kosy spal. 9 frezów 26mm G81069P 50**



GB Nut  
DE Nuss  
RU Гайка  
CZ Ořech  
SK Ořech  
HU Dió  
RO Piuliță

Kod EAN  
5901477118999

John Gardener  
Kod produktu  
**Nakrętka mocowania przekładni-noża kosy spalinowej G81069R 400**



GB Spring for clutch assy  
DE Kupplungsfeder  
RU Пружина сцепления  
CZ Pružina spojky ku křovinořezom  
SK Pružina spojky ku křovinořezom  
HU Kuplung rugó  
RO Arc ambreiaj

Kod EAN  
5901477128578

John Gardener  
Kod produktu  
**Sprężyna do szcęk sprzęgła G81069T 200**



GB Head with square mode 26mm  
DE Kegelfradgetriebe 26mm  
RU Угловая головка 26мм  
CZ Úhlová převodovka křovinořezu  
SK Úhlová prevodovka křovinořezu  
HU Kúpfogaskerék  
RO Cap trimmer

Kod EAN  
5901477128585

John Gardener  
Kod produktu  
**Przekładnia kątowna, do kosy spal. 26mm kwadrat G81069W 50**



GB Cylinder set  
DE Zylinder + Kolben  
RU Цилиндр+ поршень  
CZ Válcce kompletní  
SK Válcce kompletné  
HU Komplet henger+ dugó gyűrű  
RO Kit cilindru

Kod EAN  
5901477124181

John Gardener  
Kod produktu  
**Komplet cylinder+tłok do kosy spalinowej 52cc 44mm G81106 50**



GB Cylinder set  
DE Zylinder + Kolben  
RU Цилиндр+ поршень  
CZ Válcce kompletní  
SK Válcce kompletné  
HU Komplet henger+ dugó gyűrű  
RO Kit cilindru

Kod EAN  
5901477124150

John Gardener  
Kod produktu  
**Komplet cylinder+tłok do kosy spalinowej 43cc 40mm G81110 50**



# Osprzęt do podkaszarek / Brush Cutter Accessories



montaż: walek  
9 frezów

srednica rury  
28 mm

← 320mm →



GB Case for brushcutter  
DE Koffer für Freischneider  
RU Чехол для кустореза  
CZ Pouzdro pro křovinořez  
SK Puzdro na křovinořez  
HU Szerszám kefékhez  
RO Cauciuc pentru percutie



Kod EAN  
5901477153396  
Kod produktu  
G83018



GB Tiller  
DE Kultivator  
RU Культиватор  
CZ Kultivátor  
SK Kultivátor  
HU Kultivátor  
RO Cultivator



Kod EAN  
5901477150814  
Kod produktu  
G84007

John Gardener Pokrowiec podkaszarki spalinowej John Gardener G83018 36

John Gardener Glebogryzarka-adapter do kosy spal. 32cm (28mm) G84007 6





GB Circular brush  
DE Stahldraht-Scheibenbürste  
RU Щетка круглая  
CZ Okružní kartáč drátěný  
SK Okružná kefa drôtený  
HU Tarcás drótkefe  
RO Perie rotunda pt. bormasina



**Szczotka druciana do podkaszarki 200x25,4 PROFI** G00649 20



GB Circular brush  
DE Stahldraht-Scheibenbürste  
RU Щетка круглая  
CZ Okružní kartáč drátěný  
SK Okružná kefa drôtený  
HU Tarcás drótkefe  
RO Perie rotunda pt. bormasina



**Szczotka druciana do podkaszarki 200x25,4mm Keltin** K00035 50

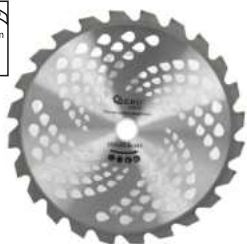
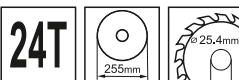

GB Blade  
DE Rodungssägeblatt  
RU Диск для кустореза  
CZ Nůž křovinořezu  
SK Nôž křovinorezu  
HU Körfűrészlap  
RO Disc taietor motocoasa



**Tarcza z widią do podkaszarki spal. 255x25,4mmx24T** G78180 50

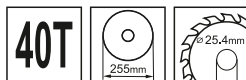

GB Blade  
DE Rodungssägeblatt  
RU Диск для кустореза  
CZ Nůž křovinořezu  
SK Nôž křovinorezu  
HU Körfűrészlap  
RO Disc taietor motocoasa



**Tarcza z widią do podkaszarki spal. 255x25,4mmx40T** G78181 50

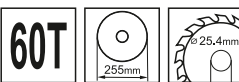

GB Blade  
DE Rodungssägeblatt  
RU Диск для кустореза  
CZ Nůž křovinořezu  
SK Nôž křovinorezu  
HU Körfűrészlap  
RO Disc taietor motocoasa



**Tarcza z widią do podkaszarki spal. 255x25,4mmx60T** G78182 50



GB Nylon cutter  
DE Trimmerkopf  
RU Головка триммерная  
CZ Strunová hlava  
SK Strunová hlava  
HU Damil fej  
RO Cap cu cablu



**Głowica żyłkowa od podkaszarki standard** G81066 50



GB Nylon cutter  
DE Trimmerkopf  
RU Головка триммерная  
CZ Strunová hlava  
SK Strunová hlava  
HU Damil fej  
RO Cap cu cablu



**Głowica żyłkowa AUTOMAT do podkaszarki** G81066Y 50



GB 8T blade  
DE 8 Zähne Rodungssägeblatt  
RU Диск для кустореза 8зубы  
CZ Kotoúč 8-zubý  
SK Kotoúč 8-zubý  
HU Vágókorong  
RO Disc Taietor



**Tarcza tnąca do kosi 8-zębów** G81069L 100



GB 3T blade  
DE 3 Zähne Rodungssägeblatt  
RU Диск для кустореза 3зубы  
CZ Kotoúč 3-zubý  
SK Kotoúč 3-zubý  
HU Vágókorong  
RO Disc Taietor



**Tarcza tnąca do kosi- 3-zęby** G81069M 100



GB Nylon cutter  
DE Trimmerkopf  
RU Головка триммерная  
CZ Strunová hlava  
SK Strunová hlava  
HU Damil fej  
RO Cap cu cablu



**Głowica żyłkowa PROFI/czarna/ do podkaszarki** G81069N 50



GB Nylon brush for brushcutter  
DE Nylonbürste für Freischneider  
RU Нейлоновая щетка для мотокосы  
CZ Nylonový kartáč pro křovinořez  
SK Nylonová kefa pre křovinorez  
HU Nylon kefe eszetvágóhoz  
RO Perie de nailon pentru perie



**Szczotka nylonowa do kosi 200x25,4mm** G81069S 20





GB Trimmer plate for brush cutter  
 DE Fadenkopf für motosense  
 RU Триммер кусторезов головка резак  
 CZ Kovová strunová hlava na křovinořez  
 SK Kovová strunová hlava na křovinořez  
 HU Sövényvágó fej  
 RO Cap mosor trimmer



John Gardener Kod produktu **Trymer do podkaszarki spalinowej G81069U 100**



GB Nylon cutter  
 DE Trimmerkopf  
 RU Головка триммерная  
 CZ Strunová hlava  
 SK Strunová hlava  
 HU Damil fej  
 RO Cap cu cablu



John Gardener Kod produktu **Głowica żyłkowa alu-szybkiego montażu żyłki G81069X 50**

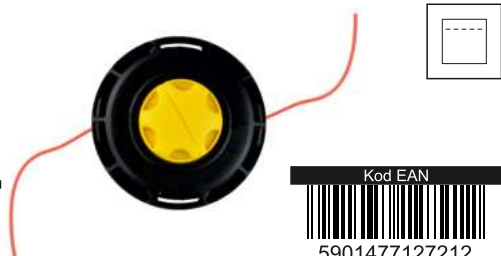

GB Nylon cutter  
 DE Trimmerkopf  
 RU Головка триммерная  
 CZ Strunová hlava  
 SK Strunová hlava  
 HU Damil fej  
 RO Cap cu cablu



John Gardener Kod produktu **Głowica żyłkowa EASY-LOAD do podkaszarki G81069Y 50**

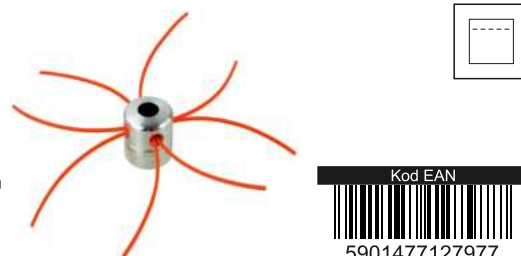

GB Line head  
 DE Trimmerkopf  
 RU Головка с леской  
 CZ Strunová hlava  
 SK Strunová hlava  
 HU Damil fej  
 RO Cap cu cablu



John Gardener Kod produktu **Aluminiowa głowica z żyłką do kosy Autocut G81069Z 100**



100m



5901477156731



5901477156762

GB Nylon line hardened  
 DE Mähfaden für Rasentrimmer Gestärkt  
 RU Леска на катушке для триммера силенный  
 CZ Struna do strunové sekačky  
 SK Struna do strunové kosačky  
 HU Damil szegélynyíró géphez  
 RO Furtun gradina

John Gardener Kod produktu **Żyłka do podkaszarki zbrojona (okrągła) 2,4mmx100m G73940 24**  
**Żyłka do podkaszarki zbrojona (okrągła) 2,7mmx100m G73943 20**  
**Żyłka do podkaszarki zbrojona (okrągła) 3,0mmx100m G73946 12**



100m



5901477156748



5901477156779

GB Nylon line hardened  
 DE Mähfaden für Rasentrimmer Gestärkt  
 RU Леска на катушке для триммера силенный  
 CZ Struna do strunové sekačky  
 SK Struna do strunové kosačky  
 HU Damil szegélynyíró géphez  
 RO Furtun gradina

John Gardener Kod produktu **Żyłka do podkaszarki zbrojona (kwadrat) 2,4mmx100m G73941 24**  
**Żyłka do podkaszarki zbrojona (kwadrat) 2,7mmx100m G73944 20**  
**Żyłka do podkaszarki zbrojona (kwadrat) 3,0mmx100m G73947 8**



100m



5901477156755



5901477156786

GB Nylon line hardened  
 DE Mähfaden für Rasentrimmer Gestärkt  
 RU Леска на катушке для триммера силенный  
 CZ Struna do strunové sekačky  
 SK Struna do strunové kosačky  
 HU Damil szegélynyíró géphez  
 RO Furtun gradina

John Gardener Kod produktu **Żyłka do podkaszarki zbrojona(gwiazdka) 2,4mmx100 G73942 24**  
**Żyłka do podkaszarki zbrojona(gwiazdka) 2,7mmx100 G73945 24**  
**Żyłka do podkaszarki zbrojona(gwiazdka) 3,0mmx100 G73948 20**



1LB



5901477139178



5901477139185

GB Nylon line hardened  
 DE Mähfaden für Rasentrimmer Gestärkt  
 RU Леска на катушке для триммера силенный  
 CZ Struna do strunové sekačky  
 SK Struna do strunové kosačky  
 HU Damil szegélynyíró géphez  
 RO Furtun gradina

John Gardener Kod produktu **Żyłka do podkaszarki okrągła 2.0mmx1LB (126m) G73950 24**  
**Żyłka do podkaszarki okrągła 2.4mmx1LB (88m) G73951 24**  
**Żyłka do podkaszarki okrągła 3.0mmx1LB (56m) G73952 24**





GB Nylon line hardened  
DE Mähfaden für Rasentrimmer Gestärkt  
RU Леска на катушке для триммера силеный  
CZ Struna do strunové sekačky  
SK Struna do strunové kosačky  
HU Damil szegélynyíró géphez  
RO Furtun gradina

John Gardener	Kod produktu	
Żyłka do podkaszarki karbowana 2,0mmx1LB (175m)	G73953	24
Żyłka do podkaszarki karbowana 2,4mmx1LB (122m)	G73954	24
Żyłka do podkaszarki karbowana 3,0mmx1LB (78m)	G73955	24



GB Nylon line hardened  
DE Mähfaden für Rasentrimmer Gestärkt  
RU Леска на катушке для триммера силеный  
CZ Struna do strunové sekačky  
SK Struna do strunové kosačky  
HU Damil szegélynyíró géphez  
RO Furtun gradina

John Gardener	Kod produktu	
Żyłka do podkaszarki karbowana 2,7mmx300m	G73957	8
Żyłka do podkaszarki karbowana 2,4mmx300m	G73958	8
Żyłka do podkaszarki karbowana 2,0mmx300m	G73959	8



GB Nylon line hardened  
DE Mähfaden für Rasentrimmer Gestärkt  
RU Леска на катушке для триммера силеный  
CZ Struna do strunové sekačky  
SK Struna do strunové kosačky  
HU Damil szegélynyíró géphez  
RO Furtun gradina

John Gardener	Kod produktu	
Żyłka do podkaszarki zbrojona(okragła) 1,3mmx15m	G73960-4	120
Żyłka do podkaszarki zbrojona(okragła) 1,6mmx15m	G73960-3	120
Żyłka do podkaszarki zbrojona(okragła) 2,0mmx15m	G73960-2	120
Żyłka do podkaszarki zbrojona(okragła) 2,4mmx15m	G73962	120
Żyłka do podkaszarki zbrojona(okragła) 2,7mmx15m	G73960-1	80
Żyłka do podkaszarki zbrojona(okragła) 2,7mmx15m	G73960-1	80



GB Nylon line hardened  
DE Mähfaden für Rasentrimmer Gestärkt  
RU Леска на катушке для триммера силеный  
CZ Struna do strunové sekačky  
SK Struna do strunové kosačky  
HU Damil szegélynyíró géphez  
RO Furtun gradina

John Gardener	Kod produktu	
Żyłka do podkaszarki zbrojona(kwadrat) 1,3mmx15m	G73964-4	120
Żyłka do podkaszarki zbrojona(kwadrat) 1,6mmx15m	G73964-3	120
Żyłka do podkaszarki zbrojona(kwadrat) 2,0mmx15m	G73964-2	120
Żyłka do podkaszarki zbrojona (kwadrat) 2,4mmx15m	G73966	80
Żyłka do podkaszarki zbrojona(kwadrat) 2,7mmx15m	G73964-1	80
Żyłka do podkaszarki zbrojona(kwadrat) 3,0mmx15m	G73964	80

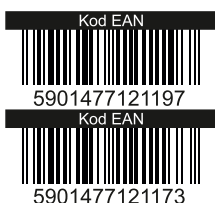

GB Nylon line hardened  
DE Mähfaden für Rasentrimmer Gestärkt  
RU Леска на катушке для триммера силеный  
CZ Struna do strunové sekačky  
SK Struna do strunové kosačky  
HU Damil szegélynyíró géphez  
RO Furtun gradina

John Gardener	Kod produktu	
Żyłka do podkaszarki zbrojona (okragła) 2,4mmx50m	G73963	40
Żyłka do podkaszarki zbrojona (okragła) 3,0mmx50m	G73961	20

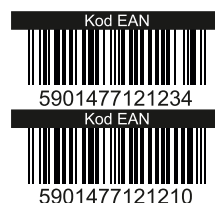

GB Nylon line hardened  
DE Mähfaden für Rasentrimmer Gestärkt  
RU Леска на катушке для триммера силеный  
CZ Struna do strunové sekačky  
SK Struna do strunové kosačky  
HU Damil szegélynyíró géphez  
RO Furtun gradina

John Gardener	Kod produktu	
Żyłka do podkaszarki zbrojona (kwadrat) 2,4mmx50m	G73967	20
Żyłka do podkaszarki zbrojona (kwadrat) 3,0mmx50m	G73965	20





Kod EAN  
5901477175459

Kod EAN  
5901477121265

Kod EAN  
5901477175442

Kod EAN  
5901477121241

GB Nylon line hardened  
DE Mähfaden für Rasentrimmer Gestärkt  
RU Леска на катушке для триммера силенный  
CZ Struna do strunové sekačky  
SK Struna do strunové kosačky  
HU Damil szegélynyíró géphez  
RO Furtun gradina

John Gardener	Kod produktu	
Żyłka do podkaszarki zbrojona(karbowana)2,0mmx15	G73968-2	120
Żyłka do podkaszarki zbrojona(karbowana)2,4mmx15	G73970	80
Żyłka do podkaszarki zbrojona(karbowana)2,7mmx15	G73968-1	80
Żyłka do podkaszarki zbrojona(karbowana)3,0mmx15	G73968	80



Kod EAN  
5901477121272

Kod EAN  
5901477121258

GB Nylon line hardened  
DE Mähfaden für Rasentrimmer Gestärkt  
RU Леска на катушке для триммера силенный  
CZ Struna do strunové sekačky  
SK Struna do strunové kosačky  
HU Damil szegélynyíró géphez  
RO Furtun gradina

John Gardener	Kod produktu	
Żyłka do podkaszarki zbrojona(karbowana)2,4mmx50	G73971	40
Żyłka do podkaszarki zbrojona(karbowana)3,0mmx50	G73969	20



Kod EAN  
5901477116773

Kod EAN  
5901477121296

GB Nylon line hardened  
DE Mähfaden für Rasentrimmer Gestärkt  
RU Леска на катушке для триммера силенный  
CZ Struna do strunové sekačky  
SK Struna do strunové kosačky  
HU Damil szegélynyíró géphez  
RO Furtun gradina

John Gardener	Kod produktu	
Żyłka do podkaszarki pięciokąt 2,4mmx30m	G73981	80
Żyłka do podkaszarki pięciokąt 3,0mmx30m	G73978	40



Kod EAN  
5901477123696

Kod EAN  
5901477121302

GB Nylon line hardened  
DE Mähfaden für Rasentrimmer Gestärkt  
RU Леска на катушке для триммера силенный  
CZ Struna do strunové sekačky  
SK Struna do strunové kosačky  
HU Damil szegélynyíró géphez  
RO Furtun gradina

John Gardener	Kod produktu	
Żyłka do podkaszarki pięciokąt 2,4mmx100m	G73983	24
Żyłka do podkaszarki pięciokąt 3,0mmx100m	G73979	20



GB Nylon line hardened  
DE Mähfaden für Rasentrimmer Gestärkt  
RU Леска на катушке для триммера силенный  
CZ Struna do strunové sekačky  
SK Struna do strunové kosačky  
HU Damil szegélynyíró géphez  
RO Furtun gradina

Kod EAN  
5901477116766

John Gardener

Kod produktu

Żyłka do podkaszarki pięciokąt 2,4mmx10m G73980 120

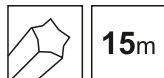

Kod EAN  
5901477175473

Kod EAN  
5901477175466

Kod EAN  
5901477121289

John Gardener

Kod produktu

Żyłka do podkaszarki pięciokąt 2,0mmx15m G73977-2 120

Żyłka do podkaszarki pięciokąt 2,7mmx15m G73977-1 80

Żyłka do podkaszarki pięciokąt 3,0mmx15m G73977 80

John Gardener	Kod produktu	
Żyłka do podkaszarki pięciokąt 2,0mmx15m	G73977-2	120
Żyłka do podkaszarki pięciokąt 2,7mmx15m	G73977-1	80
Żyłka do podkaszarki pięciokąt 3,0mmx15m	G73977	80



GB Nylon line hardened  
DE Mähfaden für Rasentrimmer Gestärkt  
RU Леска на катушке для триммера силенный  
CZ Struna do strunové sekačky  
SK Struna do strunové kosačky  
HU Damil szegélynyíró géphez  
RO Furtun gradina

Kod EAN  
5901477116780

John Gardener

Kod produktu

Żyłka do podkaszarki sześciokąt 2,4mmx10m G73985 120

John Gardener	Kod produktu	
Żyłka do podkaszarki sześciokąt 2,4mmx10m	G73985	120



GB Nylon line hardened  
DE Mähfaden für Rasentrimmer Gestärkt  
RU Леска на катушке для триммера силенный  
CZ Struna do strunové sekačky  
SK Struna do strunové kosačky  
HU Damil szegélynyíró géphez  
RO Furtun gradina

Kod EAN  
5901477116797

John Gardener

Kod produktu

Żyłka do podkaszarki sześciokąt 2,4mmx30m G73986 80

John Gardener	Kod produktu	
Żyłka do podkaszarki sześciokąt 2,4mmx30m	G73986	80



GB Nylon line hardened  
DE Mähfaden für Rasentrimmer Gestärkt  
RU Леска на катушке для триммера силенный  
CZ Struna do strunové sekačky  
SK Struna do strunové kosačky  
HU Damil szegélynyíró géphez  
RO Furtun gradina

Kod EAN  
5901477116827

John Gardener

Kod produktu

Żyłka do podkaszarki sześciokąt 2,4mmx50m G73987 40

John Gardener	Kod produktu	
Żyłka do podkaszarki sześciokąt 2,4mmx50m	G73987	40



GB Nylon line hardened  
DE Mähfaden für Rasentrimmer Gestärkt  
RU Леска на катушке для триммера силенный  
CZ Struna do strunové sekačky  
SK Struna do strunové kosačky  
HU Damil szegélynyíró géphez  
RO Furtun gradina

Kod EAN  
5901477123702

John Gardener

Kod produktu

Żyłka do podkaszarki sześciokąt 2,4mmx100m G73984 24

John Gardener	Kod produktu	
Żyłka do podkaszarki sześciokąt 2,4mmx100m	G73984	24





15m



GB Nylon line hardened  
DE Mähfaden für Rasentrimmer Gestärkt  
RU Леска на катушке для триммера силенный  
CZ Struna do strunové sekačky  
SK Struna do strunové kosačky  
HU Damil szegélynyíró géphez  
RO Furtun gradina

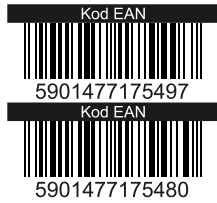

John Gardener	Kod produktu	
Żyłka do podkaszarki sześciokąt 2,0mmx15m	G73988-2	120
Żyłka do podkaszarki sześciokąt 2,7mmx15m	G73988-1	80



10m



GB Nylon line hardened  
DE Mähfaden für Rasentrimmer Gestärkt  
RU Леска на катушке для триммера силенный  
CZ Struna do strunové sekačky  
SK Struna do strunové kosačky  
HU Damil szegélynyíró géphez  
RO Furtun gradina



John Gardener	Kod produktu	
Żyłka do podkaszarki siedmiokąt 2,7mmx10m	G73988	120



30m



GB Nylon line hardened  
DE Mähfaden für Rasentrimmer Gestärkt  
RU Леска на катушке для триммера силенный  
CZ Struna do strunové sekačky  
SK Struna do strunové kosačky  
HU Damil szegélynyíró géphez  
RO Furtun gradina



John Gardener	Kod produktu	
Żyłka do podkaszarki siedmiokąt 2,7mmx30m	G73989	40



100m



GB Nylon line hardened  
DE Mähfaden für Rasentrimmer Gestärkt  
RU Леска на катушке для триммера силенный  
CZ Struna do strunové sekačky  
SK Struna do strunové kosačky  
HU Damil szegélynyíró géphez  
RO Furtun gradina



John Gardener	Kod produktu	
Żyłka do podkaszarki siedmiokąt 2,7mmx100m	G73990	24



10m



GB Nylon line hardened  
DE Mähfaden für Rasentrimmer Gestärkt  
RU Леска на катушке для триммера силенный  
CZ Struna do strunové sekačky  
SK Struna do strunové kosačky  
HU Damil szegélynyíró géphez  
RO Furtun gradina



John Gardener	Kod produktu	
Żyłka do podkaszarki okrągła 2,4mmx10m	G73995-2	240
Żyłka do podkaszarki okrągła 2,7mmx10m	G73995-1	200



12m



GB Nylon line hardened  
DE Mähfaden für Rasentrimmer Gestärkt  
RU Леска на катушке для триммера силенный  
CZ Struna do strunové sekačky  
SK Struna do strunové kosačky  
HU Damil szegélynyíró géphez  
RO Furtun gradina



John Gardener	Kod produktu	
Żyłka do podkaszarki okrągła 3mmx12m	G73995	80



15m



GB Nylon line hardened  
DE Mähfaden für Rasentrimmer Gestärkt  
RU Леска на катушке для триммера силенный  
CZ Struna do strunové sekačky  
SK Struna do strunové kosačky  
HU Damil szegélynyíró géphez  
RO Furtun gradina



John Gardener	Kod produktu	
Żyłka do podkaszarki okrągła 1,3mmx15m	G73999	120
Żyłka do podkaszarki okrągła 1,6mmx15m	G73991	240
Żyłka do podkaszarki okrągła 2,0mmx15m	G73993	192



15m



GB Nylon line hardened  
DE Mähfaden für Rasentrimmer Gestärkt  
RU Леска на катушке для триммера силенный  
CZ Struna do strunové sekačky  
SK Struna do strunové kosačky  
HU Damil szegélynyíró géphez  
RO Furtun gradina



John Gardener	Kod produktu	
Żyłka do podkaszarki karbowana 2,4mmx15m	G73996	80



100m



GB Nylon line hardened  
DE Mähfaden für Rasentrimmer Gestärkt  
RU Леска на катушке для триммера силенный  
CZ Struna do strunové sekačky  
SK Struna do strunové kosačky  
HU Damil szegélynyíró géphez  
RO Furtun gradina



John Gardener	Kod produktu	
Żyłka do podkaszarki karbowana 2,4mmx100m	G73997	24



10m



GB Nylon line hardened  
DE Mähfaden für Rasentrimmer Gestärkt  
RU Леска на катушке для триммера силенный  
CZ Struna do strunové sekačky  
SK Struna do strunové kosačky  
HU Damil szegélynyíró géphez  
RO Furtun gradina



John Gardener	Kod produktu	
Żyłka do podkaszarki kwadrat 1,3mmx10m	G73998-5	288
Żyłka do podkaszarki kwadrat 1,6mmx10m	G73998-4	240
Żyłka do podkaszarki kwadrat 2,0mmx10m	G73998-3	240
Żyłka do podkaszarki kwadrat 2,4mmx10m	G73998-2	240
Żyłka do podkaszarki kwadrat 2,7mmx10m	G73998-1	200
Żyłka do podkaszarki kwadrat 3,0mmx10m	G73998	144



# Aeratory i wertykulatory / Aerators



196cc  
max 6.5KM  
400mm  
50mm / 150mm  
2500 ml  
40 l



230V-50Hz  
45 l  
380mm



GB Scarifier  
DE Vertikutierer  
RU Аэратор-скарификатор  
CZ Vertikutátor  
SK Vertikutátor  
HU Irtóborona  
RO Scarificator



Kod EAN  
5901477138294  
Kod produktu  
G84005 1

#Aerator spalinowy 40cm 6,5HP

GB Scarifier  
DE Vertikutierer  
RU Аэратор-скарификатор  
CZ Vertikutátor  
SK Vertikutátor  
HU Irtóborona  
RO Scarificator



Kod EAN  
5901477150142  
Kod produktu  
G83002 1

Aerator wertykulator 2w1 JG PREMIUM

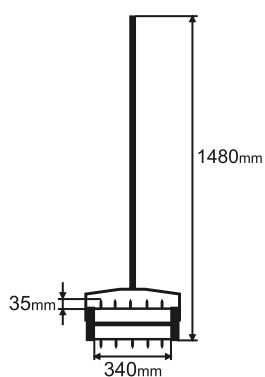

46mm  
x13



GB Scarifier  
DE Vertikutierer  
RU Аэратор-скарификатор  
CZ Vertikutátor  
SK Vertikutátor  
HU Irtóborona  
RO Scarificator



Kod EAN  
5901477176159  
Kod produktu  
G72069 4

Aerator walcowy do trawy

GB Scarifier  
DE Vertikutierer  
RU Аэратор-скарификатор  
CZ Vertikutátor  
SK Vertikutátor  
HU Irtóborona  
RO Scarificator



Kod EAN  
5901477134388  
Kod produktu  
G72070 10

Aerator sandalowy na buty z kolcami



# Glebogryzarki / Cultivators



<b>139cc</b>	<small>max</small> 5.0KM
360mm	100mm
800 ml	



<b>139cc</b>	<small>max</small> 5.0KM
560mm	100mm
800 ml	



GB Tiller  
DE Kultivator  
RU Культиватор  
CZ Kultivátor  
SK Kultivátor  
HU Kultivátor  
RO Cultivator

Kod EAN

5901477137037

John Gardener Kod produktu **#Glebogryzarka spalinowa 5.0HP 36cm G84000 1**

GB Tiller  
DE Kultivator  
RU Культиватор  
CZ Kultivátor  
SK Kultivátor  
HU Kultivátor  
RO Cultivator

Kod EAN

5901477137044

John Gardener Kod produktu **#Glebogryzarka spalinowa 5.0HP 56cm G84001 1**



52cc  
moc nominalna  
2.6kW

300mm  
5-10mm



52cc  
moc nominalna  
1.4kW

280mm  
5-10mm



GB Tiller  
DE Kultivator  
RU Культиватор  
CZ Kultivátor  
SK Kultivátor  
HU Kultivátor  
RO Cultivator

Kod EAN  
5901477186615

John Gardener  
Kod produktu  
Glebogryzarka spalinowa 30cm G84008 1

GB Tiller  
DE Kultivator  
RU Культиватор  
CZ Kultivátor  
SK Kultivátor  
HU Kultivátor  
RO Cultivator

Kod EAN  
5901477186622

John Gardener  
Kod produktu  
Gardener Glebogryzarka spalinowa 28cm G84009 1

52cc  
max  
5.2kW

370mm  
100mm  
150mm

1200 ml



230V-50Hz  
280obr/min

450mm  
220mm



GB Tiller  
DE Kultivator  
RU Культиватор  
CZ Kultivátor  
SK Kultivátor  
HU Kultivátor  
RO Cultivator

Kod EAN  
5901477146350

John Gardener  
Kod produktu  
Glebogryzarka spalinowa 37cm G84004 1

GB Electric tiller  
DE Elektrische kultivator  
RU Электрический культиватор  
CZ Elektrický kultivátor  
SK Elektrický kultivátor  
HU Elektromos kultivátor  
RO Cultivator electric

Kod EAN  
5901477129124

John Gardener  
Kod produktu  
Elektryczna glebogryzarka-kultywator 45cm G83003 1

230V-50Hz  
380obr/min

320mm  
200mm



GB Electric tiller  
DE Elektrische kultivator  
RU Электрический культиватор  
CZ Elektrický kultivátor  
SK Elektrický kultivátor  
HU Elektromos kultivátor  
RO Cultivator electric

Kod EAN  
5901477124501

John Gardener  
Kod produktu  
Elektryczna glebogryzarka-kultywator 32cm G83004 1

GB Hand cultivator with handle  
DE Handkultivator, eingefasst  
RU Культиватор ручной садовый  
CZ Ruční kultivátor s násadou  
SK Ručné kultivátor s násadou  
HU Kézi kultivátor, nyeles  
RO Cultivator cu maner

Kod EAN  
5901477161346

John Gardener  
Kod produktu  
Kultywator ręczny - spulchniacz gleby G72075 12



# Dmuchawy/odkurzacze ogrodowe / Leaf Blowers & Garden Vacuums



<b>25.4cc</b>	<b>max</b> 1.0kW
800 ml	30 : 1
<b>MAX</b> 7500/min	<b>45L</b>



<b>42.7cc</b>	<b>max nominalna</b> 1.25kW
1200 ml	<b>MAX</b> 7000/min



GB Vacuum cleaner - Leaf blower  
DE Staubsauger - Laubbläser  
RU Садовый пылесос  
CZ Motorový fúkač  
SK Motorový fúkač  
HU Lombszívó, lombfúvó  
RO Aspirator - Suflanta frunzelor



Kod EAN  
5901477136023  
Kod produktu

**Odkurzacz-dmuchała spaliniowa do liści JG G84010 1**

GB Vacuum cleaner - Leaf blower  
DE Staubsauger - Laubbläser  
RU Садовый пылесос  
CZ Motorový fúkač  
SK Motorový fúkač  
HU Lombszívó, lombfúvó  
RO Aspirator - Suflanta frunzelor



Kod EAN  
5901477156892  
Kod produktu

**Dmuchała spaliniowa do liści JG Strong G84011 1**

230V-50Hz	<b>max</b> 3000W
<b>MAX</b> 14000/min	<b>45L</b>
<b>IP20</b>	regulacja obrotów



230V-50Hz	<b>max</b> 3300W
<b>MAX</b> 1400/min	<b>45L</b>
<b>IP20</b>	regulacja obrotów



GB Vacuum leaf blower  
DE Vakuu-Laubgebläse  
RU Вакуум листьев воздуходувки  
CZ Elektrický vysávač/fúkač  
SK Elektrický vysávač / fúkač  
HU Lombszívó / lombfúvó  
RO Aspirator / suflantă frunze



Kod EAN  
5901477127335  
Kod produktu

**Odkurzacz-dmuchała do liści 3-funkcyjny Standard G81070 1**

GB Vacuum leaf blower  
DE Vakuu-Laubgebläse  
RU Вакуум листьев воздуходувки  
CZ Elektrický vysávač/fúkač  
SK Elektrický vysávač / fúkač  
HU Lombszívó / lombfúvó  
RO Aspirator / suflantă frunze



Kod EAN  
5901477127427  
Kod produktu

**Odkurzacz-dmuchała do liści 3-funkcyjny BIG G81071 1**



# Piły, pilarki / Chain Saws



<b>43cc</b>	moc nominalna ⚡ 2.3KM
max 40cm	<b>18"</b>
520 ml	25 : 1



<b>55cc</b>	moc nominalna ⚡ 2.3KM
max 50cm	<b>20"</b>
520 ml	25 : 1



GB Gasoline chainsaw  
DE Motorsägen  
RU Бензопила  
CZ Motorová pila  
SK Motorová pila  
HU Benzin láncfűrész  
RO Drujba pe benzina



Kod EAN  
5901477127588  
Kod produktu  
G82001 1

Piła spalinowa łańcuchowa Standard 4500 18"

GB Gasoline chainsaw  
DE Motorsägen  
RU Бензопила  
CZ Motorová pila  
SK Motorová pila  
HU Benzin láncfűrész  
RO Drujba pe benzina



Kod EAN  
5901477127595  
Kod produktu  
G82002 1

Piła spalinowa łańcuchowa BIG 5800 20"

<b>25.4cc</b>	moc nominalna ⚡ 1.5KM
max 25cm	<b>10"</b>
230 ml	25 : 1



GB Gasoline chainsaw  
DE Motorsägen  
RU Бензопила  
CZ Motorová pila  
SK Motorová pila  
HU Benzin láncfűrész  
RO Drujba pe benzina



Kod EAN  
5901477120657  
Kod produktu  
G82005 1

Piła spalinowa do gałęzi German 2500

230V-50Hz	max ⚡ 710W
max 18cm	0.2 L
229-289 cm	

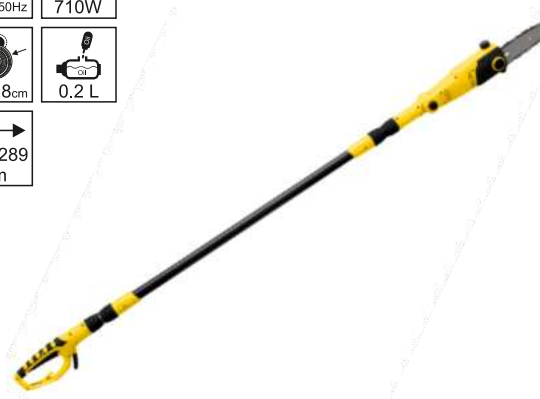

GB Electrical branch chainsaw  
DE Astkettensäge  
RU Электрический высотерез  
CZ Řetězová vuvětrovací pila  
SK Odvetovacia motorová pila  
HU Motoros ágváágó fűrész  
RO Fierastrau electric telescopic pentru taiat crengi



Kod EAN  
5901477151149  
Kod produktu  
G83008 1

Piła elektryczna łańcuchowa do gałęzi na wysięgniku



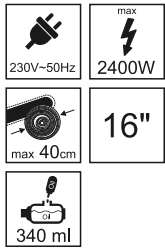

GB Electrical branch chainsaw  
DE Astkettensäge  
RU Электрический высторез  
CZ Řetězová uuvětovovací pila  
SK Odvetovacia motorová pila  
HU Motoros ágváágó furész  
RO Fierastrau electric telescopic pentru taiat crengi



GB Electrical branch chainsaw  
DE Astkettensäge  
RU Электрический высторез  
CZ Řetězová uuvětovovací pila  
SK Odvetovacia motorová pila  
HU Motoros ágváágó furész  
RO Fierastrau electric telescopic pentru taiat crengi



John Gardener  
Kod produktu  
**Pila elektryczna łańcuchowa (side engine) 2400W G82007 2**

John Gardener  
Kod produktu  
**Pila elektryczna łańcuchowa (straight engine) 2400W G82008 2**

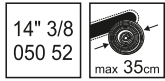

GB Chainsaw guide bar  
DE Kettensägeführung  
RU Шина для бензопил  
CZ Vodicí lišta k řetězové pile  
SK Vodiaca lišta k reťazovej pile  
HU Láncevezető  
RO Lama de ghidai pt. ferastrau



John Gardener  
Kod produktu  
**Prowadnica 14"3/8,050 52 do Partnera G74000 20**

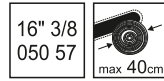

GB Chainsaw guide bar  
DE Kettensägeführung  
RU Шина для бензопил  
CZ Vodicí lišta k řetězové pile  
SK Vodiaca lišta k reťazovej pile  
HU Láncevezető  
RO Lama de ghidai pt. ferastrau



John Gardener  
Kod produktu  
**Prowadnica 16" 3/8,050 57 do Partnera G74001 20**

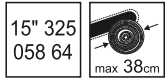

GB Chainsaw guide bar  
DE Kettensägeführung  
RU Шина для бензопил  
CZ Vodicí lišta k řetězové pile  
SK Vodiaca lišta k reťazovej pile  
HU Láncevezető  
RO Lama de ghidai pt. ferastrau



John Gardener  
Kod produktu  
**Prowadnica 15"325,058 64 do Husqvarny G74002 20**



GB Chainsaw guide bar  
DE Kettensägeführung  
RU Шина для бензопил  
CZ Vodicí lišta k řetězové pile  
SK Vodiaca lišta k reťazovej pile  
HU Láncevezető  
RO Lama de ghidai pt. ferastrau



John Gardener  
Kod produktu  
**Prowadnica 14"3/8,050 50 do Sthila G74003 20**

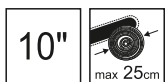

GB Chainsaw guide bar  
DE Kettensägeführung  
RU Шина для бензопил  
CZ Vodicí lišta k řetězové pile  
SK Vodiaca lišta k reťazovej pile  
HU Láncevezető  
RO Lama de ghidai pt. ferastrau



John Gardener  
Kod produktu  
**Prowadnica do pily G82005 German 10" G74006 20**



GB Chainsaw guide bar  
DE Kettensägeführung  
RU Шина для бензопил  
CZ Vodicí lišta k řetězové pile  
SK Vodiaca lišta k reťazovej pile  
HU Láncevezető  
RO Lama de ghidai pt. ferastrau



John Gardener  
Kod produktu  
**Prowadnica do pily G82001 ,18" 325 1,5mm G74008 25**



GB Chainsaw guide bar  
DE Kettensägeführung  
RU Шина для бензопил  
CZ Vodicí lišta k řetězové pile  
SK Vodiaca lišta k reťazovej pile  
HU Láncevezető  
RO Lama de ghidai pt. ferastrau



John Gardener  
Kod produktu  
**Prowadnica do pily G82002 BIG 22" 325 1,5mm G74009 20**

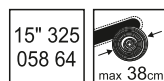

GB Guide bar + 2x chain  
DE Führungsschiene + 2x die Kette zu den Sägen  
RU Шина для цепи для электропилы + 2x цепь к пилам  
CZ Lišta vodicí + 2x řetěz  
SK Lišta vodiace + 2x reťaz  
HU Láncevezető + 2db lánc  
RO Lama de ghidai pt. ferastrau + 2 Lant pt. drujba



John Gardener  
Kod produktu  
**Prowadnica 15"325 + 2xłańcuch 058 64 do Husqvarny G74010 20**



14" 3/8  
050 50



max 35cm

GB Guide bar + 2x chain  
DE Führungsschiene + 2x die Kette zu den Sägen  
RU Шина для цепи для электропилы + 2x цепь к пилам  
CZ Lišta vodičů + 2x řetěz  
SK Lišta vodiace + 2x reťaz  
HU Lánvezető + 2db lánc  
RO Lama de ghidai pt. ferastrau + 2 Lant pt. drujba

Kod EAN  
5901477117428

Kod produktu  
G74011 20

John Gardener

Prowadnica 14"3/8" + 2łańcuch 050 50 do Stihla

14" 3/8  
050 52



max 35cm

GB Guide bar + 2x chain  
DE Führungsschiene + 2x die Kette zu den Sägen  
RU Шина для цепи для электропилы + 2x цепь к пилам  
CZ Lišta vodičů + 2x řetěz  
SK Lišta vodiace + 2x reťaz  
HU Lánvezető + 2db lánc  
RO Lama de ghidai pt. ferastrau + 2 Lant pt. drujba

Kod EAN  
5901477117435

Kod produktu  
G74012 20

John Gardener

Prowadnica 14"3/8" + 2łańcuch 050 52 do Partnera

3.8"  
1.3mm



GB Drive links for chains  
DE Antriebs Links für Ketten  
RU Приводных звеньев для цепей  
CZ Spojky a nůty řetězu  
SK Sponky a nity reťaze  
HU Lánckarbantartás  
RO Nituri lant drujba

Kod EAN  
5901477123467

Kod produktu  
G74018 5000

John Gardener

Spinki do łańcucha do pił 3,8" 1,3mm

325"  
1.5mm



GB Drive links for chains  
DE Antriebs Links für Ketten  
RU Приводных звеньев для цепей  
CZ Spojky a nůty řetězu  
SK Sponky a nity reťaze  
HU Lánckarbantartás  
RO Nituri lant drujba

Kod EAN  
5901477123481

Kod produktu  
G74019 5000

John Gardener

Spinki do łańcucha do pił 325"1,5mm

18" 325  
1.5mm  
050 72T



GB Chain for chainsaw  
DE Kette für Kettensägen  
RU Цепь для бензопилы  
CZ Řetěz pro řetězové pily  
SK Reťaz pre reťazové pily  
HU Láncláncfűrészt  
RO Lant pt. drujba

Kod EAN  
5901477135934

Kod produktu  
G74026 100

John Gardener

Łańcuch do piły G82001 Standard 18" 325 1.5mm 050

20" 3/8  
1.5mm  
058 76T



GB Chain for chainsaw  
DE Kette für Kettensägen  
RU Цепь для бензопилы  
CZ Řetěz pro řetězové pily  
SK Reťaz pre reťazové pily  
HU Láncláncfűrészt  
RO Lant pt. drujba

Kod EAN  
5901477143380

Kod produktu  
G74027 100

John Gardener

Łańcuch do piły G82002 BIG 20" 3/8" 1.5mm 058

10" 3/8  
050 40T



GB Chain for chainsaw  
DE Kette für Kettensägen  
RU Цепь для бензопилы  
CZ Řetěz pro řetězové pily  
SK Reťaz pre reťazové pily  
HU Láncláncfűrészt  
RO Lant pt. drujba

Kod EAN  
5901477143397

Kod produktu  
G74028 100

John Gardener

Łańcuch do piły G82005 German 10" 3/8 050

14" 3/8  
050 52T



GB Chain for chainsaw  
DE Kette für Kettensägen  
RU Цепь для бензопилы  
CZ Řetěz pro řetězové pily  
SK Reťaz pre reťazové pily  
HU Láncláncfűrészt  
RO Lant pt. drujba

Kod EAN  
5901477113093

Kod produktu  
G74030 100

John Gardener

Łańcuch 3/8"050 52T do Partnera 14"

16" 3/8  
050 56T



GB Chain for chainsaw  
DE Kette für Kettensägen  
RU Цепь для бензопилы  
CZ Řetěz pro řetězové pily  
SK Reťaz pre reťazové pily  
HU Láncláncfűrészt  
RO Lant pt. drujba

Kod EAN  
5901477112911

Kod produktu  
G74040 100

John Gardener

Łańcuch 3/8"050 56T do Partnera 16"

14" 3/8  
050 50T



GB Chain for chainsaw  
DE Kette für Kettensägen  
RU Цепь для бензопилы  
CZ Řetěz pro řetězové pily  
SK Reťaz pre reťazové pily  
HU Láncláncfűrészt  
RO Lant pt. drujba

Kod EAN  
5901477113154

Kod produktu  
G74050 100

John Gardener

Łańcuch 3/8" 050 50T do Stihla 14"

16" 3/8  
050 55T



GB Chain for chainsaw  
DE Kette für Kettensägen  
RU Цепь для бензопилы  
CZ Řetěz pro řetězové pily  
SK Reťaz pre reťazové pily  
HU Láncláncfűrészt  
RO Lant pt. drujba

Kod EAN  
5901477112928

Kod produktu  
G74060 100

John Gardener

Łańcuch 3/8" 050 55T do Stihla 16"

16" 3/8  
063 60T



GB Chain for chainsaw  
DE Kette für Kettensägen  
RU Цепь для бензопилы  
CZ Řetěz pro řetězové pily  
SK Reťaz pre reťazové pily  
HU Láncláncfűrészt  
RO Lant pt. drujba

Kod EAN  
5901477116551



Kod produktu  
G74070 50

John Gardener

Łańcuch 3/8 063 60T do Stihla 16"



15" 325  
058 64T

GB Chain for chainsaw  
DE Kette für Kettensägen  
RU Цепь для бензопилы  
CZ Řetěz pro řetězové pily  
SK Retaz pre retazové pily  
HU Láncláncfűrész  
RO Lant pt. drujba

Kod EAN  
5901477112935

John Gardener Kod produktu  
Łańcuch 325 058 64T do Husqvarny 15" G74011 100

18" 325  
058 72T



GB Chain for chainsaw  
DE Kette für Kettensägen  
RU Цепь для бензопилы  
CZ Řetěz pro řetězové pily  
SK Retaz pre retazové pily  
HU Láncláncfűrész  
RO Lant pt. drujba

Kod EAN  
5901477112942

John Gardener Kod produktu  
Łańcuch 325 058 72T do Husqvarny 18" G74090 100

14" 3/8  
050 52



GB Chainsaw guide bar  
DE Kettensägeführung  
RU Шина для бензопил  
CZ Vodičí lišta k řetězové pile  
SK Vodiaca lišta k retazovej pile  
HU Láncevezető  
RO Lama de ghidai pt. ferastrau

Kod EAN  
5901477172786

Keltin Kod produktu  
Prowadnica 14"3/8,050 52 do Partnera K02400 20

16" 3/8  
050 57



GB Chainsaw guide bar  
DE Kettensägeführung  
RU Шина для бензопил  
CZ Vodičí lišta k řetězové pile  
SK Vodiaca lišta k retazovej pile  
HU Láncevezető  
RO Lama de ghidai pt. ferastrau

Kod EAN  
5901477172793

Keltin Kod produktu  
Prowadnica 16" 3/8,050 57 do Partnera K02401 20

15" 325  
058 64



GB Chainsaw guide bar  
DE Kettensägeführung  
RU Шина для бензопил  
CZ Vodičí lišta k řetězové pile  
SK Vodiaca lišta k retazovej pile  
HU Láncevezető  
RO Lama de ghidai pt. ferastrau

Kod EAN  
5901477172809

Keltin Kod produktu  
Prowadnica 15"325,058 64 do Husqvarny K02402 20

14" 3/8  
050 50



GB Chainsaw guide bar  
DE Kettensägeführung  
RU Шина для бензопил  
CZ Vodičí lišta k řetězové pile  
SK Vodiaca lišta k retazovej pile  
HU Láncevezető  
RO Lama de ghidai pt. ferastrau

Kod EAN  
5901477172816

Keltin Kod produktu  
Prowadnica 14"3/8,050 50 do Stihla K02403 20

15" 325  
058 64



GB Guide bar + 2x chain  
DE Führungsschiene + 2x die Kette zu den Sägen  
RU Шина для цепи для электропилы + 2x цепь к пилам  
CZ Lišta vodičí + 2x řetěz  
SK Lišta vodiace + 2x retaz  
HU Láncevezető + 2db lánc  
RO Lama de ghidai pt. ferastrau + 2 Lant pt. drujba

Kod EAN  
5901477172823

Keltin Kod produktu  
Prowadnica 15"325 + 2xłańcuch 058 64 do Husqvarny K02410 20

14" 3/8"  
050 50



GB Guide bar + 2x chain  
DE Führungsschiene + 2x die Kette zu den Sägen  
RU Шина для цепи для электропилы + 2x цепь к пилам  
CZ Lišta vodičí + 2x řetěz  
SK Lišta vodiace + 2x retaz  
HU Láncevezető + 2db lánc  
RO Lama de ghidai pt. ferastrau + 2 Lant pt. drujba

Kod EAN  
5901477172830

Keltin Kod produktu  
Prowadnica 14"3/8" + 2xłańcuch 050 50 do Stihla K02411 20

14" 3/8"  
050 52



GB Guide bar + 2x chain  
DE Führungsschiene + 2x die Kette zu den Sägen  
RU Шина для цепи для электропилы + 2x цепь к пилам  
CZ Lišta vodičí + 2x řetěz  
SK Lišta vodiace + 2x retaz  
HU Láncevezető + 2db lánc  
RO Lama de ghidai pt. ferastrau + 2 Lant pt. drujba

Kod EAN  
5901477172847

Keltin Kod produktu  
Prowadnica 14"3/8+ 2xłańcuch 050 52 do Partnera K02412 20

14" 3/8"  
050 52T



GB Chain for chainsaw  
DE Kette für Kettensägen  
RU Цепь для бензопилы  
CZ Řetěz pro řetězové pily  
SK Retaz pre retazové pily  
HU Láncláncfűrész  
RO Lant pt. drujba

Kod EAN  
5901477172854

Keltin Kod produktu  
Łańcuch 3/8"050 52T do Partnera 14" K02430 100

16" 3/8"  
050 56T



GB Chain for chainsaw  
DE Kette für Kettensägen  
RU Цепь для бензопилы  
CZ Řetěz pro řetězové pily  
SK Retaz pre retazové pily  
HU Láncláncfűrész  
RO Lant pt. drujba

Kod EAN  
5901477172861

Keltin Kod produktu  
Łańcuch 3/8"050 56T do Partnera 16" K02440 100

14" 3/8"  
050 50T





GB Chain for chainsaw  
DE Kette für Kettensägen  
RU Цепь для бензопилы  
CZ Řetěz pro řetězové pily  
SK Retaz pre retazové pily  
HU Láncláncfűrész  
RO Lant pt. drujba

Kod EAN  
5901477172878

Keltin Kod produktu  
Łańcuch 3/8" 050 50T do Stihla 14" K02450 100



15" 325  
058 64T



GB Chain for chainsaw  
DE Kette für Kettensägen  
RU Цепь для бензопилы  
CZ Řetěz pro řetězové pily  
SK Reťaz pre reťazové pily  
HU Lánc láncfűrész  
RO Lanț pt. drujba

Kod EAN  
5901477172908

Kod produktu  
Łańcuch 325 058 64T do Husquarny 15" K02480 100

8"  
x  
5/32"



GB Chain saw file  
DE Runde Kettenfeile  
RU Новые надфили  
CZ Kulatý pilní na řetězu  
SK Okrúhly usilovní na reťaze  
HU Láncvágó körfűrész  
RO Pilă rotundă pt. lanțuri

Kod EAN  
5901477123412

Kod produktu  
Pilnik okrągły 4mm do ostrzenia łańcucha G74092 600

3/8"  
x  
.325"



GB Chain saw file  
DE Runde Kettenfeile  
RU Новые надфили  
CZ Kulatý pilní na řetězu  
SK Okrúhly usilovní na reťaze  
HU Láncvágó körfűrész  
RO Pilă rotundă pt. lanțuri

Kod EAN  
5901477171741

Kod produktu  
Pilnik okrągły 4,5mm do ostrzenia łańcucha G74093 600

8"  
x  
3/16"



GB Chain saw file  
DE Runde Kettenfeile  
RU Новые надфили  
CZ Kulatý pilní na řetězu  
SK Okrúhly usilovní na reťaze  
HU Láncvágó körfűrész  
RO Pilă rotundă pt. lanțuri

Kod EAN  
5901477123429

Kod produktu  
Pilnik okrągły 4,8mm do ostrzenia łańcucha G74094 600

0.404"



GB Chain saw file  
DE Runde Kettenfeile  
RU Новые надфили  
CZ Kulatý pilní na řetězu  
SK Okrúhly usilovní na reťaze  
HU Láncvágó körfűrész  
RO Pilă rotundă pt. lanțuri

Kod EAN  
5901477123436

Kod produktu  
Pilnik okrągły 5,5mm do ostrzenia łańcucha G74095 600

do pil:  
14"/16"/  
18"/20"



GB Chainsaw Sharpener  
DE Kettenschleifgerät  
RU Настольный заточной министанок  
CZ Bruska řetězu  
SK Brúska reťaze  
HU Fűrészláncélező  
RO Masina pentru ascuțit lanțuri

Kod EAN  
5901477160899

Kod produktu  
Ostrzałka do łańcuchów manualna G74096 50

do  
G74096



GB A disc for manual chain sharpener  
DE Eine Scheibe für den manuellen Kettenschärfer  
RU Диск для ручной заточки цепей  
CZ Koloúč pro ruční ostříčku řetězu  
SK Koloúč na ručnú brúsku reťaze  
HU Kézi láncélező tárcsa  
RO Un disc pentru ascuțitorul manual de lanț

Kod EAN  
5901477160714

Kod produktu  
Tarcza do ostrzałki łańcuchów manualnej CG74096A 300



GB Guide for chain saw file  
DE Führung für die Kettenfeile  
RU Направляющая для напильника для цепей  
CZ Vedení pro pilník na řetězu  
SK Vedenie pre pilník na reťaze  
HU Megvezető a láncfűrészhez  
RO Ghidaj pt. pila pt. lanțuri

Kod EAN  
5901477159176

Kod produktu  
Ostrzałka ramowa ręczna łańcuchów-prowadnik pilnika G74097 20

230V~50Hz 230W  
3000-3500/min  
145x22.3x3x2mm



GB Chainsaw Sharpener  
DE Kettenschleifgerät  
RU Настольный заточной министанок  
CZ Bruska řetězu  
SK Brúska reťaze  
HU Fűrészláncélező  
RO Masina pentru ascuțit lanțuri

Kod EAN  
5901477142505

Kod produktu  
Ostrzałka elektryczna do łańcuchów BIG PREMIUM G81021 3

230V~50Hz 220W  
7500/min  
100x10x3x2mm



GB Chainsaw Sharpener  
DE Kettenschleifgerät  
RU Настольный заточной министанок  
CZ Bruska řetězu  
SK Brúska reťaze  
HU Fűrészláncélező  
RO Masina pentru ascuțit lanțuri

Kod EAN  
5901477159192

Kod produktu  
Ostrzałka elektryczna do łańcuchów G81029 6



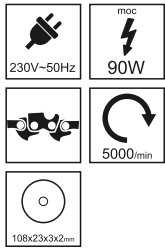

GB Chainsaw Sharpener  
DE Kettenschleifgerät  
RU Настольный заточной министанок  
CZ Bruska řetězu  
SK Brúska reťaze  
HU Fűrészláncélező  
RO Masina pentru ascutit lanturi



**Ostrzałka do łańcuchów 90W** Kod produktu **G81207** 4

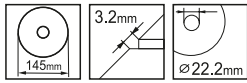

GB Disc sharpening chains  
DE Schild zu dem Schärfen Kette  
RU Диск для заточки цепи  
CZ Brusný kotouč  
SK Brúsny kotúč  
HU Kőszőrűkő láncélező géphez korong  
RO Discuri de ascuțire



**Tarcza do ostrzenia łańcuchów 145x3.2x22.2** Kod produktu **G81201B** 100

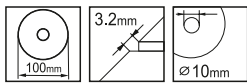

GB Disc sharpening chains  
DE Schild zu dem Schärfen Kette  
RU Диск для заточки цепи  
CZ Brusný kotouč  
SK Brúsny kotúč  
HU Kőszőrűkő láncélező géphez korong  
RO Discuri de ascuțire



**Tarcza do ostrzenia łańcuchów 100x10x3.2** Kod produktu **G81202** 100

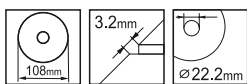

GB Disc sharpening chains  
DE Schild zu dem Schärfen Kette  
RU Диск для заточки цепи  
CZ Brusný kotouč  
SK Brúsny kotúč  
HU Kőszőrűkő láncélező géphez korong  
RO Discuri de ascuțire



**Tarcza do ostrzałki łańcuchów 108x22,2x3,2mm** Kod produktu **G81207A** 100



GB Cylinder set  
DE Zylinder + Kolben  
RU Цилиндр+ поршень  
CZ Válcce kompletní  
SK Valce kompletné  
HU Komplet henger+ dugó gyűrű  
RO Kit cilindru



**Komplet cylinder + tłok do Stihla TS410 50mm** Kod produktu **G81107** 20

John Gardener



GB Chainsaw chain break  
DE Sägeketten Entnietgerät  
RU Станок для расклепки цепей  
CZ Roznitovačka pilových řetězů  
SK Roznitovačka pilových reťazí  
HU Szegecskinyomó fűrészláncához  
RO Masina spart lant drujba



**Przyrząd do roznitowywania łańcuchów** Kod produktu **G74098** 4

EKO



GB Chainsaw chain spinner  
DE Sägekette nietgerät  
RU Станок для клепания цепей  
CZ Nitovačka pilových řetězů  
SK Nitovačka pilových reťazí  
HU Szegecselő készülék fűrészláncához  
RO Masina de nituit lanturi si de spart lanturi



**Przyrząd do nitowania łańcuchów** Kod produktu **G74099** 4

EKO

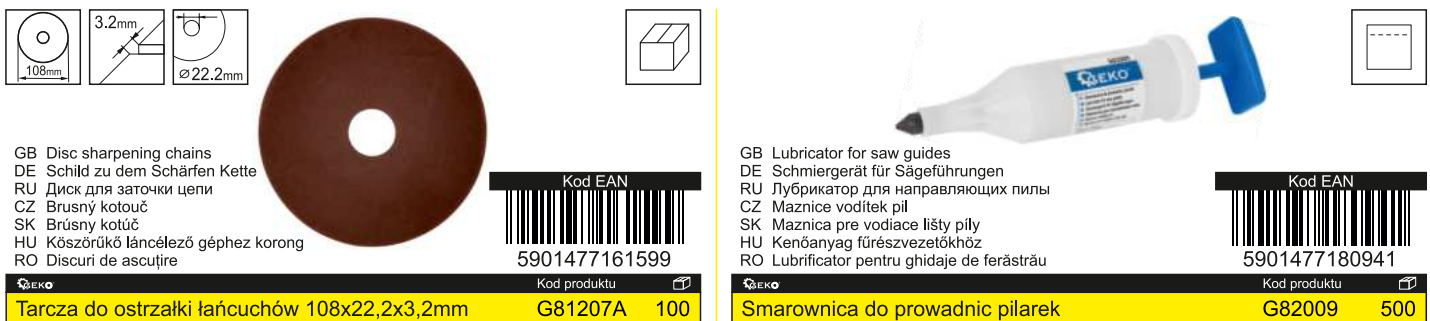

GB Lubricator for saw guides  
DE Schmiergerät für Sägeführungen  
RU Лубрикатор для направляющих пилы  
CZ Maznice vodiček pil  
SK Maznica pre vodiace lišty píly  
HU Kenőanyag fűrészvezetőkhoz  
RO Lubrificator pentru ghidaje de ferăstrău



**Smarownica do prowadnic pilarek** Kod produktu **G82009** 500

EKO

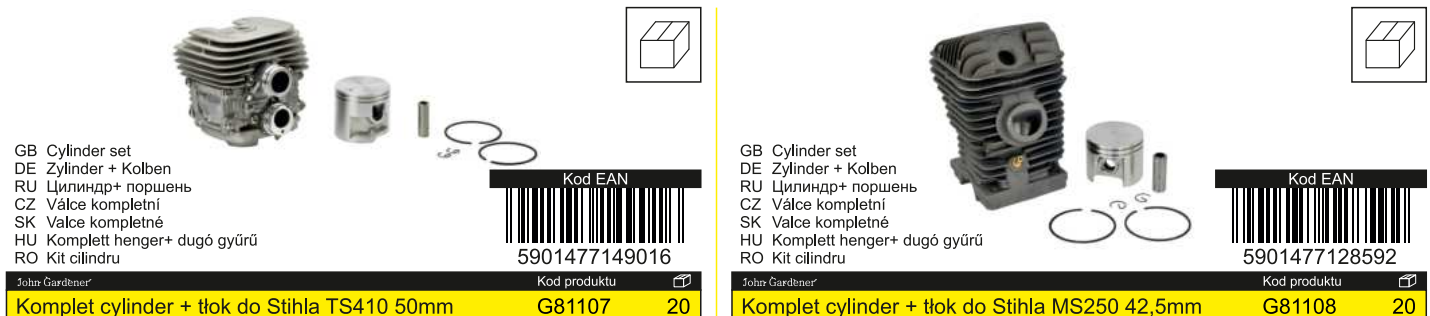

GB Cylinder set  
DE Zylinder + Kolben  
RU Цилиндр+ поршень  
CZ Válcce kompletní  
SK Valce kompletné  
HU Komplet henger+ dugó gyűrű  
RO Kit cilindru



**Komplet cylinder + tłok do Stihla MS250 42,5mm** Kod produktu **G81108** 20

John Gardener





GB Cylinder set  
DE Zylinder + Kolben  
RU Цилиндр+ поршень  
CZ Válcce kompletní  
SK Válcce kompletné  
HU Komplet henger+ dugó gyűrü  
RO Kit cilindru

Kod EAN  
5901477128608

Kod produktu  
G81109 40

**Komplet cylinder + tlok do Stihla MS260 44,7mm**



GB Cylinder set  
DE Zylinder + Kolben  
RU Цилиндр+ поршень  
CZ Válcce kompletní  
SK Válcce kompletné  
HU Komplet henger+ dugó gyűrü  
RO Kit cilindru

Kod EAN  
5901477128615

Kod produktu  
G81111 20

**Komplet cylinder + tlok do Partnera 351/352/370/401**



GB Cylinder set  
DE Zylinder + Kolben  
RU Цилиндр+ поршень  
CZ Válcce kompletní  
SK Válcce kompletné  
HU Komplet henger+ dugó gyűrü  
RO Kit cilindru

Kod EAN  
5901477128622

Kod produktu  
G81112 40

**Komplet cylinder + tlok do stihla 170 37mm**



GB Cylinder set  
DE Zylinder + Kolben  
RU Цилиндр+ поршень  
CZ Válcce kompletní  
SK Válcce kompletné  
HU Komplet henger+ dugó gyűrü  
RO Kit cilindru

Kod EAN  
5901477124174

Kod produktu  
G81113 20

**Komplet cylinder + tlok do stihla 180 38mm**



GB Cylinder set  
DE Zylinder + Kolben  
RU Цилиндр+ поршень  
CZ Válcce kompletní  
SK Válcce kompletné  
HU Komplet henger+ dugó gyűrü  
RO Kit cilindru

Kod EAN  
5901477128639

Kod produktu  
G81114 20

**Komplet cylinder + tlok do stihla 230 40mm**



GB Cylinder set  
DE Zylinder + Kolben  
RU Цилиндр+ поршень  
CZ Válcce kompletní  
SK Válcce kompletné  
HU Komplet henger+ dugó gyűrü  
RO Kit cilindru

Kod EAN  
5901477149023

Kod produktu  
G81115 20

**Komplet cylinder + tlok do Husqvarny 55 46mm**



GB Cylinder set  
DE Zylinder + Kolben  
RU Цилиндр+ поршень  
CZ Válcce kompletní  
SK Válcce kompletné  
HU Komplet henger+ dugó gyűrü  
RO Kit cilindru

Kod EAN  
5901477149030

Kod produktu  
G81116 20

**Komplet cylinder + tlok do Husqvarny 236/240 39mm**



GB Cylinder set  
DE Zylinder + Kolben  
RU Цилиндр+ поршень  
CZ Válcce kompletní  
SK Válcce kompletné  
HU Komplet henger+ dugó gyűrü  
RO Kit cilindru

Kod EAN  
5901477136238

Kod produktu  
G81117 50

**Komplet cylinder + tlok do piły spalinowej 52cc 45mm**



GB Cylinder set  
DE Zylinder + Kolben  
RU Цилиндр+ поршень  
CZ Válcce kompletní  
SK Válcce kompletné  
HU Komplet henger+ dugó gyűrü  
RO Kit cilindru

Kod EAN  
5901477136047

Kod produktu  
G81119 20

**Komplet cylinder + tlok do Husqvarny 350 44mm**



GB Carburetor  
DE Vergaser  
RU карбюратор  
CZ Karburátor  
SK Karburátor  
HU Karburátor  
RO Carburator

Kod EAN  
5901477128653

Kod produktu  
G81120 100

**Gaźnik do stihla MS170/MS180**



GB Carburetor  
DE Vergaser  
RU карбюратор  
CZ Karburátor  
SK Karburátor  
HU Karburátor  
RO Carburator

Kod EAN  
5901477128660

Kod produktu  
G81121 100

**Gaźnik do stihla MS230/MS250**





GB Carburetor  
DE Vergaser  
RU карбюратор  
CZ Karburátor  
SK Karburátor  
HU Karburátor  
RO Carburator

Kod EAN  
5901477128677

Kod produktu  
G81122 100



**Gaźnik do Partnera 350/351/370**

GB Carburetor  
DE Vergaser  
RU карбюратор  
CZ Karburátor  
SK Karburátor  
HU Karburátor  
RO Carburator

Kod EAN  
5901477136054



John Gardener Kod produktu 50  
**Gaźnik do chińskiej piły spalinowej 52cc** G81123 100

GB Carburetor  
DE Vergaser  
RU карбюратор  
CZ Karburátor  
SK Karburátor  
HU Karburátor  
RO Carburator

Kod EAN  
5901477136061



John Gardener Kod produktu 50  
**Gaźnik do Husqvarny 136,137,141,142** G81124 100

GB Carburetor  
DE Vergaser  
RU карбюратор  
CZ Karburátor  
SK Karburátor  
HU Karburátor  
RO Carburator

Kod EAN  
5901477128684

John Gardener Kod produktu 50  
**Gaźnik do Husqvarny 340 345 346 350** G81125 100

GB Carburetor  
DE Vergaser  
RU карбюратор  
CZ Karburátor  
SK Karburátor  
HU Karburátor  
RO Carburator

Kod EAN  
5901477128691



John Gardener Kod produktu 50  
**Gaźnik do stihla 120 200 250 300 350** G81126 100



GB Clutch  
DE Kupplung  
RU Сцепление  
CZ Spojka  
SK Spojka  
HU Kuplung  
RO Ambreiaj

Kod EAN  
5901477149054

John Gardener Kod produktu 50  
**Sprzęgło do piły spalinowej Partner 351 Hus137** G81130 100

GB Clutch  
DE Kupplung  
RU Сцепление  
CZ Spojka  
SK Spojka  
HU Kuplung  
RO Ambreiaj

Kod EAN  
5901477149061

John Gardener Kod produktu 50  
**Sprzęgło do stihla 170 230 250** G81131 100



GB Clutch  
DE Kupplung  
RU Сцепление  
CZ Spojka  
SK Spojka  
HU Kuplung  
RO Ambreiaj

Kod EAN  
5901477128707

John Gardener Kod produktu 50  
**Zestaw sprzęgło + bęben sprzęgła + łożysko** G81135 100



GB Starter china chainsaw  
DE Starter für chinese kettensäge  
RU Стартер для бензопилы  
CZ Startování na motorové pily  
SK Startovanie na motorovej píly  
HU Indító kínai láncfűrészhöz  
RO Demaror

Kod EAN  
5901477128714

John Gardener Kod produktu 50  
**Starter do chińskiej piły spalinowej 43cc-58cc** G81136 100



GB Brake + housing for gasoline chainsaw  
DE Bremse + Gehäuse für Kettensäge  
RU Тормозная панель бензопилой  
CZ Skříň pro píly  
SK Skriňa pre píly  
HU Láncfűrész alkatrészek  
RO Capac frana lant

Kod EAN  
5901477123856

John Gardener Kod produktu 50  
**Hamulec + obudowa do piły spalinowej** G81137 50



GB Ignition coil for chain saws  
DE Spule-Anlassmodul für Kettensäge  
RU Модуль Coil-события для бензопилы  
CZ Zapalovací svíčka  
SK Zapalovacia sviečka  
HU Gyújtótékercs  
RO Bobina aprindere

Kod EAN  
5901477124273

John Gardener Kod produktu 50  
**Pompka oleju do piły spalinowej** G81139 300



GB Clutch  
DE Kupplung  
RU Сцепление  
CZ Spojka  
SK Spojka  
HU Kuplung  
RO Ambreiaj

Kod EAN  
5901477128721

John Gardener Kod produktu 50  
**Bęben sprzęgła + łożysko do Partnera 351** G81140 100





GB Clutch  
DE Kupplung  
RU Сцепление  
CZ Spojka  
SK Spojka  
HU Kuplung  
RO Ambreiaj

Kod EAN  
5901477128738

John Gardener Kod produktu 50  
**Bęben sprzęgła + łożysko do stihla 170 180 230 250** G81141 100

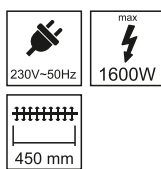
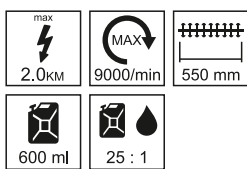

# Nožyce do žywopłotu, trawy i krzewów / Hedge, grass and shrub shears



GB Petrol hedge trimmer  
DE Benzin-Heckenscheren  
RU Бензоножницы  
CZ Plostořih na živé ploty  
SK Plostořih na živé ploty  
HU Benzines sövényvágó  
RO Tuns gard viu



Kod EAN  
5901477116735

John Gardener  
Nožyce spalinowe do żywoplotu 55cm  
Kod produktu  
G81054  
1

GB Hedge shears  
DE Heckenscheren  
RU Ножницы для живой изгороди  
CZ Nůžky na živý plot  
SK Nožnice na živý plot  
HU Sövényvágó olló  
RO Foarfece pt. gard viu



Kod EAN  
5901477118845

John Gardener  
Nožyce do żywoplotu elektryczne 450mm JG  
Kod produktu  
G83005  
4

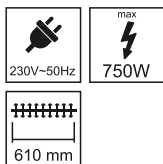

GB Hedge shears  
DE Heckenscheren  
RU Ножницы для живой изгороди  
CZ Nůžky na živý plot  
SK Nožnice na živý plot  
HU Sövényvágó olló  
RO Foarface pt. gard viu



Kod EAN  
5901477118975

John Gardener Kod produktu 4  
Nożyce do żywoplotu elektryczne 610mm JG G83007

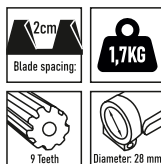

GB Hedge trimmer attachment  
DE Heckenscherenaufsatz  
RU Насадка для живой изгороди  
CZ Nástavec na nůžky na živý plot  
SK Nástavec nožnic na živý plot  
HU Sövénynyíró tartozék  
RO Accesoriu pentru tuns gard viu



Kod EAN  
5901477174766

John Gardener Kod produktu 12  
Nożyce do żywoplotu – przystawka do kosi spalinowej G81064C

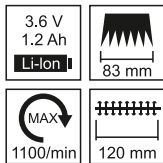

GB Cordless grass trimmer  
DE Akku-Rasentrimmer  
RU беспроводной триммер  
CZ Akumulátorová strunová sekačka  
SK Akumulátorová strunová sekačka  
HU Akkus szegélynyíró  
RO De tuns iarba cu acumulator



Kod EAN  
5901477124471

John Gardener Kod produktu 4  
Nożyce akumulatorowe do trawy/krzewów 3.6V G83011

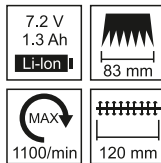

GB Cordless grass trimmer  
DE Akku-Rasentrimmer  
RU беспроводной триммер  
CZ Akumulátorová strunová sekačka  
SK Akumulátorová strunová sekačka  
HU Akkus szegélynyíró  
RO De tuns iarba cu acumulator



Kod EAN  
5901477124488

John Gardener Kod produktu 4  
Nożyce akumulatorowe do trawy/krzewów 7.2V G83012

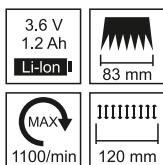

GB Cordless grass trimmer  
DE Akku-Rasentrimmer  
RU беспроводной триммер  
CZ Akumulátorová strunová sekačka  
SK Akumulátorová strunová sekačka  
HU Akkus szegélynyíró  
RO De tuns iarba cu acumulator



Kod EAN  
5901477129148

John Gardener Kod produktu 2  
Nożyce akumulatorowe do trawy/krzewów 3.6V z rączką G83013

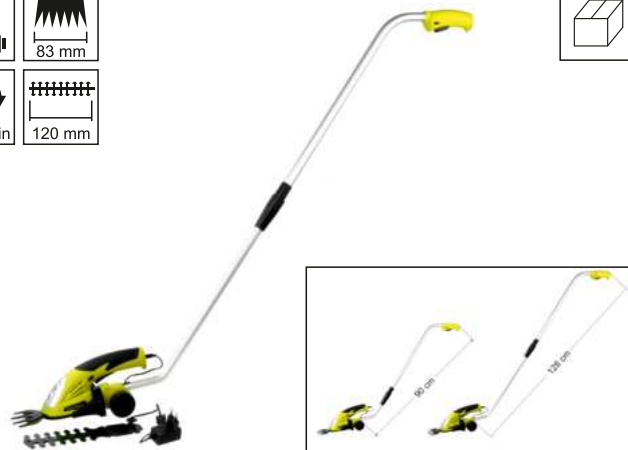
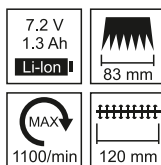

GB Cordless grass trimmer  
DE Akku-Rasentrimmer  
RU беспроводной триммер  
CZ Akumulátorová strunová sekačka  
SK Akumulátorová strunová sekačka  
HU Akkus szegélynyíró  
RO De tuns iarba cu acumulator



Kod EAN  
5901477129155

John Gardener Kod produktu 2  
Nożyce akumulatorowe do trawy/krzewów 7.2V z rączką G83014





# Przycinanie i cięcie / Pruning & Cutting

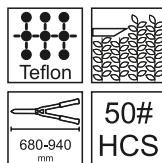
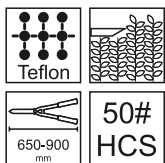

GB By-pass pruner  
DE Rebenschere  
RU Секатор  
CZ Nožnice zahradnícke  
SK Nožnice zahradnícke  
HU Metszőolló  
RO Foarfece pt. pomi



Kod EAN

John Gardener Kod produktu **Sekator teleskopowy 650-900mm do gałęzi, PP+TPR G72017 6**

GB By-pass pruner  
DE Rebenschere  
RU Секатор  
CZ Nožnice zahradnícke  
SK Nožnice zahradnícke  
HU Metszőolló  
RO Foarfece pt. pomi



Kod EAN

John Gardener Kod produktu **Sekator teleskopowy,kowadełkowy,przegubowy G72018 6**

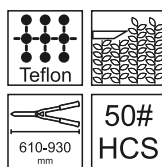
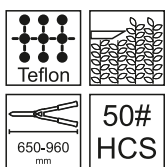

GB By-pass pruner  
DE Rebenschere  
RU Секатор  
CZ Nožnice zahradnícke  
SK Nožnice zahradnícke  
HU Metszőolló  
RO Foarfece pt. pomi



Kod EAN

John Gardener Kod produktu **Sekator teleskopowy,kowadełkowy,przegubowy G72020 6**

GB By-pass pruner  
DE Rebenschere  
RU Секатор  
CZ Nožnice zahradnícke  
SK Nožnice zahradnícke  
HU Metszőolló  
RO Foarfece pt. pomi



Kod EAN

John Gardener Kod produktu **Sekator do gałęzi teleskopowy 610-930mm G72021 6**

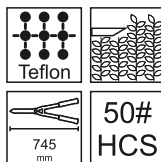
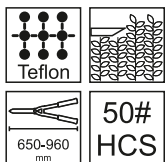

GB By-pass pruner  
DE Rebenschere  
RU Секатор  
CZ Nožnice zahradnícke  
SK Nožnice zahradnícke  
HU Metszőolló  
RO Foarfece pt. pomi



Kod EAN  
5901477114229

John Gardener Kod produktu 6  
Sekator do konarów teleskopowy, przegubowy G72022 6

GB By-pass pruner  
DE Rebenschere  
RU Секатор  
CZ Nožnice zahradnícke  
SK Nožnice zahradnícke  
HU Metszőolló  
RO Foarfece pt. pomi



Kod EAN  
5901477114281

John Gardener Kod produktu 6  
Sekator do konarów kowadełkowy, przegubowy 700mm G72023 6

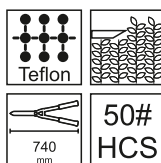
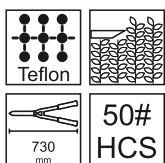

GB By-pass pruner  
DE Rebenschere  
RU Секатор  
CZ Nožnice zahradnícke  
SK Nožnice zahradnícke  
HU Metszőolló  
RO Foarfece pt. pomi



Kod EAN  
5901477114298

John Gardener Kod produktu 6  
Sekator do gałęzi 730mm ręczka PP+TPR G72024 6

GB By-pass pruner  
DE Rebenschere  
RU Секатор  
CZ Nožnice zahradnícke  
SK Nožnice zahradnícke  
HU Metszőolló  
RO Foarfece pt. pomi



Kod EAN  
5901477114236

John Gardener Kod produktu 6  
Sekator do konarów, przekładniowy, kowadełkowy duży G72025 6

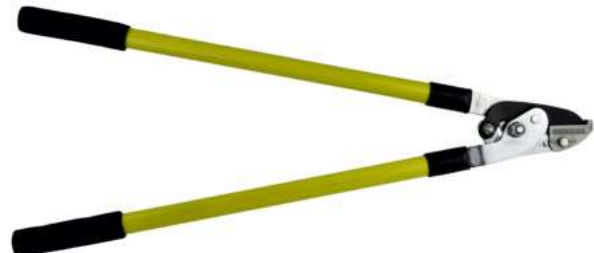
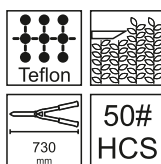
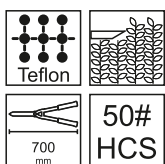

GB By-pass pruner  
DE Rebenschere  
RU Секатор  
CZ Nožnice zahradnícke  
SK Nožnice zahradnícke  
HU Metszőolló  
RO Foarfece pt. pomi



Kod EAN  
5901477114243

John Gardener Kod produktu 6  
Sekator do konarów 700mm, kowadełkowy G72026 6

GB By-pass pruner  
DE Rebenschere  
RU Секатор  
CZ Nožnice zahradnícke  
SK Nožnice zahradnícke  
HU Metszőolló  
RO Foarfece pt. pomi



Kod EAN  
5901477114250

John Gardener Kod produktu 6  
Sekator do konarów, przegubowy, kowadełkowy duży G72027 6



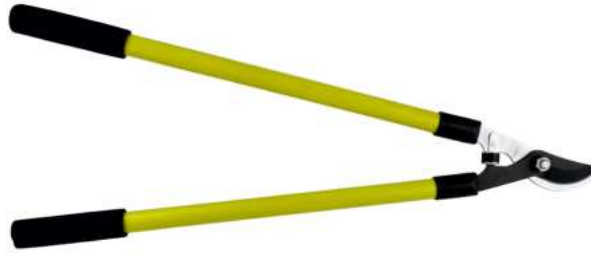
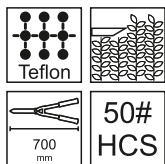
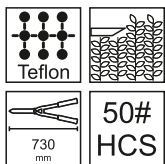

GB By-pass pruner  
DE Rebenschere  
RU Секатор  
CZ Nožnice zahradnicke  
SK Nožnice zahradnicke  
HU Metszőolló  
RO Foarfece pt. pomi



Kod EAN  
5901477114267

John Gardener Kod produktu 6  
Sekator do gałęzi 700mm, przegubowy G72028

GB By-pass pruner  
DE Rebenschere  
RU Секатор  
CZ Nožnice zahradnicke  
SK Nožnice zahradnicke  
HU Metszőolló  
RO Foarfece pt. pomi



Kod EAN  
5901477114274

John Gardener Kod produktu 12  
Sekator do gałęzi 700mm G72029

350 mm



GB Leverage tree pruner  
DE Baumsäge mit Astschere  
RU Сучкорез штанговый с пилой  
CZ Sřiřač na větve s pilovým listem  
SK Sřiřač na konáre s pilovým listom  
HU Kóteles ágvágó  
RO Fierastrau pt. pomi cu prelungitor



Kod EAN  
5901477114304

John Gardener Kod produktu 12  
Sekator tyczkowy z piłką 350mm G72057

2.4 m



GB Telescopic handle  
DE Teleskopstange  
RU Рукятка телескопическая  
CZ Teleskopický prodlužovač  
SK Teleskopický predĺžovač  
HU Teleszkópos hosszabbító  
RO Prelungitor telescopic



Kod EAN  
5901477167171

John Gardener Kod produktu 12  
Trzonek metalowy do sekatora tyczkowego 2.4m G72058

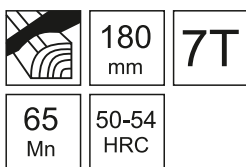

GB Hand saw for wood  
DE Handsäge  
RU Пила по дереву  
CZ Píla na dřevo  
SK Píla na drevo  
HU Fafűrész, egyenes  
RO Fierastrau „coada de vulpe” - pt. lemn



Kod EAN  
5901477145025

John Gardener Kod produktu 48  
Píla do drewna skladana 180mm, 65 Mn G33108

300 mm



GB Grass shears  
DE Handgrassschere  
RU Ножницы для стрижки травы  
CZ Nůžky na trávu  
SK Nožnice na trávu  
HU Forgatható fűvirő olló  
RO Foarfece pt. gazon



Kod EAN  
5901477114311

John Gardener Kod produktu 60  
Nožyce do trawy obrotowe PROFÍ 300mm G72054

300  
mm



GB Grass shears  
DE Handgrassschere  
RU Ножницы для стрижки травы  
CZ Nůžky na trávu  
SK Nožnice na trávu  
HU Forgatható fűviró olló  
RO Foarfece pt. gazon



5901477114328

John Gardener Kod produktu **Nożyce do trawy 300mm** G72055 60

GB By-pass pruner  
DE Rebenschere  
RU Секатор  
CZ Nožnice zahradnícke  
SK Nožnice zahradnícke  
HU Metszőolló  
RO Foarfece pt. pomi



5901477114151

John Gardener Kod produktu **Sekator do żywopłotu 520mm** G72011 12



GB By-pass pruner  
DE Rebenschere  
RU Секатор  
CZ Nožnice zahradnícke  
SK Nožnice zahradnícke  
HU Metszőolló  
RO Foarfece pt. pomi



5901477114168

John Gardener Kod produktu **Sekator do żywopłotu 640mm PROFI,alu. rączki** G72012 12

GB By-pass pruner  
DE Rebenschere  
RU Секатор  
CZ Nožnice zahradnícke  
SK Nožnice zahradnícke  
HU Metszőolló  
RO Foarfece pt. pomi



5901477114175

John Gardener Kod produktu **Sekator do żywopłotu teleskopowy 640-870mm** G72014 6



GB Garden grafting tools kit  
DE Veredelungswerkzeugsatz für den Garten  
RU Набор садовых прививочных инструментов  
CZ Sada zahradního nářadí pro roubování  
SK Súprava záhradných nástrojov na štepenie  
HU Kerti oltványkészlet  
RO Kit de unelte de altoire pentru grădină



5901477182907

SEKO Kod produktu **Sekator – nożyce do szczepienia drzew i krzewów** G71999 20

GB By-pass pruner  
DE Rebenschere  
RU Секатор  
CZ Nožnice zahradnícke  
SK Nožnice zahradnícke  
HU Metszőolló  
RO Foarfece pt. pomi



5901477114090

John Gardener Kod produktu **Sekator ogrodowy 200mm,stal.czarna rączka** G72001 60





GB By-pass pruner  
DE Rebenschere  
RU Секатор  
CZ Nožnice zahradnicke  
SK Nožnice zahradnicke  
HU Metszőolló  
RO Foarfece pt. pomi



Kod EAN  
5901477114106

John Gardener Kod produktu 60  
Sekator ogr. 200mm Profi drewniana rączka G72002 60



GB By-pass pruner  
DE Rebenschere  
RU Секатор  
CZ Nožnice zahradnicke  
SK Nožnice zahradnicke  
HU Metszőolló  
RO Foarfece pt. pomi



Kod EAN  
5901477114113

John Gardener Kod produktu 60  
Sekator ogrodniczy 200mmm,plastyk.rączka G72003 60



GB By-pass pruner  
DE Rebenschere  
RU Секатор  
CZ Nožnice zahradnicke  
SK Nožnice zahradnicke  
HU Metszőolló  
RO Foarfece pt. pomi



Kod EAN  
5901477114137

John Gardener Kod produktu 60  
Sekator ogr. 200mm Profi alu.rączka G72005 60



600 G 14"

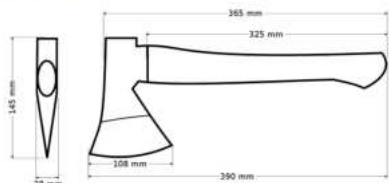

GB Axe  
DE Handbeil  
RU Топор  
CZ Sekyřka  
SK Sekerka  
HU Szekerce  
RO Toporisca



Kod EAN  
5901477100154

SEKO Kod produktu 24  
Siekiera PROFi 600Gx14" (drewniany trzonek) G72210 24

800 G 14"

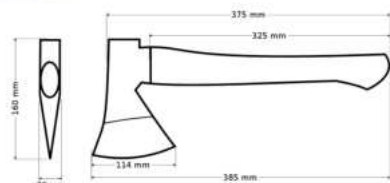

GB Axe  
DE Handbeil  
RU Топор  
CZ Sekyřka  
SK Sekerka  
HU Szekerce  
RO Toporisca



Kod EAN  
5901477100161

SEKO Kod produktu 24  
Siekiera PROFi 800Gx14" (drewniany trzonek) G72211 24

1000  
G 18"

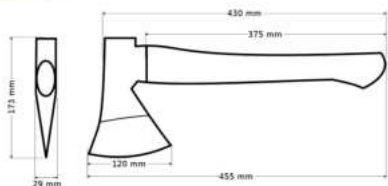

GB Axe  
DE Handbeil  
RU Tonop  
CZ Sekyrka  
SK Sekerka  
HU Szekerce  
RO Toporisca



Kod EAN  
5901477100178

**Siekiera PROFI 1000Gx18" (drewniany trzonek)**    Kod produktu **G72212**    24

1250  
G 24"

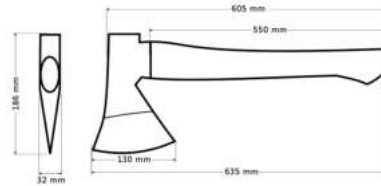

GB Axe  
DE Handbeil  
RU Tonop  
CZ Sekyrka  
SK Sekerka  
HU Szekerce  
RO Toporisca



Kod EAN  
5901477100185

**Siekiera PROFI 1250Gx24" (drewniany trzonek)**    Kod produktu **G72213**    12

1600  
G 32"

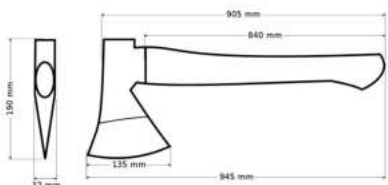

GB Axe  
DE Handbeil  
RU Tonop  
CZ Sekyrka  
SK Sekerka  
HU Szekerce  
RO Toporisca



Kod EAN  
5901477100192

**Siekiera PROFI 1600Gx32" (drewniany trzonek)**    Kod produktu **G72215**    12

600  
G 14"



GB Axe  
DE Handbeil  
RU Tonop  
CZ Sekyrka  
SK Sekerka  
HU Szekerce  
RO Toporisca



Kod EAN  
5901477100208

**Siekiera 600Gx14" fiberglass Geko Premium**    Kod produktu **G72220**    24

800  
G 15"



GB Axe  
DE Handbeil  
RU Tonop  
CZ Sekyrka  
SK Sekerka  
HU Szekerce  
RO Toporisca



Kod EAN  
5901477100215

**Siekiera 800Gx15" fiberglass Geko Premium**    Kod produktu **G72221**    24

1000  
G 18"



GB Axe  
DE Handbeil  
RU Tonop  
CZ Sekyrka  
SK Sekerka  
HU Szekerce  
RO Toporisca



Kod EAN  
5901477100222

**Siekiera 1000Gx18" fiberglass Geko Premium**    Kod produktu **G72222**    24



1250  
G 28"



GB Axe  
DE Handbeil  
RU Tonop  
CZ Sekyrka  
SK Sekerka  
HU Szekerce  
RO Toporisca



Kod EAN  
5901477100239

Siekiera 1250Gx28" fiberglass Geko Premium G72223 12

1600  
G 36"



GB Axe  
DE Handbeil  
RU Tonop  
CZ Sekyrka  
SK Sekerka  
HU Szekerce  
RO Toporisca



Kod EAN  
5901477100246

Siekiera 1600Gx36" fiberglass Geko Premium G72225 12



GB Axe  
DE Handbeil  
RU Tonop  
CZ Sekyrka  
SK Sekerka  
HU Szekerce  
RO Toporisca



Kod EAN  
5901477147814

Siekiera ciesielska - Toprek 14" 620g TVARDY T02-001 24



GB Axe  
DE Handbeil  
RU Tonop  
CZ Sekyrka  
SK Sekerka  
HU Szekerce  
RO Toporisca



Kod EAN  
5901477147821

Siekiera ciesielska 17,5" 850g TVARDY T02-002 12



GB Axe  
DE Handbeil  
RU Tonop  
CZ Sekyrka  
SK Sekerka  
HU Szekerce  
RO Toporisca



Kod EAN  
5901477147838

Siekiera rozłupująca 17,5" 1000g TVARDY T02-003 12



GB Axe  
DE Handbeil  
RU Tonop  
CZ Sekyrka  
SK Sekerka  
HU Szekerce  
RO Toporisca



Kod EAN  
5901477147845

Siekiera ciesielska 28" 1350g TVARDY T02-004 8



GB Axe  
DE Handbeil  
RU Tonop  
CZ Sekyrka  
SK Sekerka  
HU Szekerce  
RO Toporisca



Tvardy  
Siekiera Rozłupująca 28" 1550g TVARDY  
Kod produktu T02-005  
8



GB Axe  
DE Handbeil  
RU Tonop  
CZ Sekyrka  
SK Sekerka  
HU Szekerce  
RO Toporisca



Tvardy  
Siekiera ciesielska 31,5" 2150g TVARDY  
Kod produktu T02-006  
4



GB Axe  
DE Handbeil  
RU Tonop  
CZ Sekyrka  
SK Sekerka  
HU Szekerce  
RO Toporisca



Tvardy  
Siekiera Rozłupująca 31,5" 2400g TVARDY  
Kod produktu T02-007  
4



GB Axe  
DE Handbeil  
RU Tonop  
CZ Sekyrka  
SK Sekerka  
HU Szekerce  
RO Toporisca



EKO  
Siekiera rozłupująca 2 kg r.fiberglass Geko Premium  
Kod produktu G72230  
6



GB Axe  
DE Handbeil  
RU Tonop  
CZ Sekyrka  
SK Sekerka  
HU Szekerce  
RO Toporisca



EKO  
Siekiera rozłupująca 1 kg r.fiberglass Geko Premium  
Kod produktu G72231  
12



GB Axe  
DE Handbeil  
RU Tonop  
CZ Sekyrka  
SK Sekerka  
HU Szekerce  
RO Toporisca



EKO  
Siekiera rozłupująca 2,7 kg r.fiberglass Geko Premium  
Kod produktu G72232  
6



3600  
G



GB Axe  
DE Handbeil  
RU Tonop  
CZ Sekyrka  
SK Sekerka  
HU Szekerce  
RO Toporisca



Kod EAN  
5901477120619

**Siekiera rozłupująca 3,6 kg r.fiberglass Geko Premium G72233 6**

2000  
G



GB Axe  
DE Handbeil  
RU Tonop  
CZ Sekyrka  
SK Sekerka  
HU Szekerce  
RO Toporisca



Kod EAN  
5901477115141

**Siekiera rozłupująca 2 kg r.drewno Geko Premium G72234 6**

1000  
G



GB Axe  
DE Handbeil  
RU Tonop  
CZ Sekyrka  
SK Sekerka  
HU Szekerce  
RO Toporisca



Kod EAN  
5901477115134

**Siekiera rozłupująca 1 kg r.drewno Geko Premium G72235 12**



2000  
G

3000  
G

stal



235x55x34  
mm

265x58x42  
mm



GB Wood splitter  
DE Spaltkeil  
RU Клин для раскалывания бревен  
CZ Klin na štípání polen  
SK Klin na štiepanie polien  
HU Pana pt. lemn  
RO Fahasító ék



Kod EAN  
5901477173837



Kod EAN  
5901477173844

**Klin do rozłupywania drewna 2kg stalowy G72201 10**  
**Klin do rozłupywania drewna 3kg stalowy G72202 6**

115  
G

262  
G

262  
G

ABS



6"  
152x66x25  
mm

8"  
203x89x30,5  
mm

10"  
254x89x30,5  
mm



Kod EAN  
5901477173950



Kod EAN  
5901477173967



Kod EAN  
5901477173974

GB Wood splitter  
DE Spaltkeil  
RU Клин для раскалывания бревен  
CZ Klin na štípání polen  
SK Klin na štiepanie polien  
HU Pana pt. lemn  
RO Fahasító ék

**Klin drwalski do wycinki drzewa 6" ABS G72207 100**  
**Klin drwalski do wycinki drzewa 8" ABS G72208 40**  
**Klin drwalski do wycinki drzewa 10" ABS G72209 40**

# Rozdrabniacze do gałęzi / siewniki / Garden Shredders/Seeders

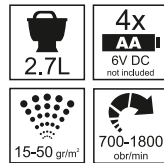
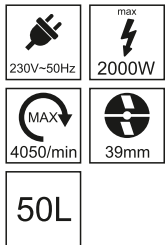

GB Garden shredder  
DE Garten-Häcksler  
RU Садовый измельчитель  
CZ Zahradní drtič  
SK Záhradná drvič  
HU Elektromos kerti szecskázó  
RO Tocător concasor electric de grădină



John Gardener  
Rozdrabniacz do gałęzi 2000W  
Kod produktu  
G81075 1

GB Garden seeder  
DE Garten-Sämaschine  
RU Садовая сеялка  
CZ Zahradní sečák  
SK Záhradná sejačka  
HU Kerti vetőgép  
RO Semănătoare de grădină



John Gardener  
Siewnik ogrodowy na baterie 2,7L  
Kod produktu  
G72065 4

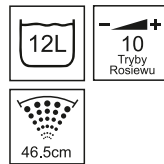
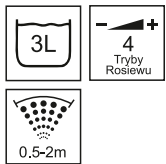

GB Garden seeder  
DE Garten-Sämaschine  
RU Садовая сеялка  
CZ Zahradní sečák  
SK Záhradná sejačka  
HU Kerti vetőgép  
RO Semănătoare de grădină



John Gardener  
Siewnik ogrodowy 3L  
Kod produktu  
G72067 8

GB Garden seeder  
DE Garten-Sämaschine  
RU Садовая сеялка  
CZ Zahradní sečák  
SK Záhradná sejačka  
HU Kerti vetőgép  
RO Semănătoare de grădină



John Gardener  
Siewnik ogrodowy 12L  
Kod produktu  
G72068 4



# Opryskiwacze ogrodowe / Sprayers



2.13kW  
 14L  
 7500/min  
 max 11m  
 4l/min



2.13kW  
 20L  
 7500/min  
 max 12m  
 4l/min



GB Diffusion gasoline sprinkler  
 DE Ruckenspritze mit Verbrennungsmotor  
 RU Диффузионный бензиновый опрыскиватель  
 CZ Motorový zadový postřikovač  
 SK Motorová chrbtovú postrekovač  
 HU Robbanómotoros hátí permetezőgépek  
 RO Dispozitiv pt. stropit cu combustibil purtat in spate



Kod EAN  
5901477124396

Kod produktu **Opryskiwacz spalinowy 14L** G81080 1

GB Diffusion gasoline sprinkler  
 DE Ruckenspritze mit Verbrennungsmotor  
 RU Диффузионный бензиновый опрыскиватель  
 CZ Motorový zadový postřikovač  
 SK Motorová chrbtovú postrekovač  
 HU Robbanómotoros hátí permetezőgépek  
 RO Dispozitiv pt. stropit cu combustibil purtat in spate



Kod EAN  
5901477124402

Kod produktu **Opryskiwacz spalinowy 20L** G81081 1

2.13kW  
 26L  
 7500/min  
 max 12m  
 4l/min



2.13kW  
 14L  
 7500/min  
 max 11m  
 4l/min



GB Diffusion gasoline sprinkler  
 DE Ruckenspritze mit Verbrennungsmotor  
 RU Диффузионный бензиновый опрыскиватель  
 CZ Motorový zadový postřikovač  
 SK Motorová chrbtovú postrekovač  
 HU Robbanómotoros hátí permetezőgépek  
 RO Dispozitiv pt. stropit cu combustibil purtat in spate



Kod EAN  
5901477124419

Kod produktu **Opryskiwacz spalinowy 26L** G81082 1

GB Diffusion gasoline sprinkler  
 DE Ruckenspritze mit Verbrennungsmotor  
 RU Диффузионный бензиновый опрыскиватель  
 CZ Motorový zadový postřikovač  
 SK Motorová chrbtovú postrekovač  
 HU Robbanómotoros hátí permetezőgépek  
 RO Dispozitiv pt. stropit cu combustibil purtat in spate



Kod EAN  
5901477140495

Kod produktu **Opryskiwacz spalinowy 14L** H00661 1

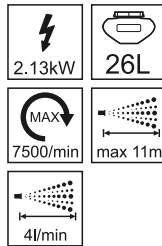
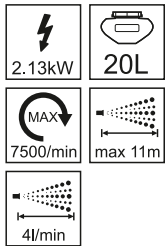

GB Diffusion gasoline sprinkler  
 DE Ruckenspritze mit Verbrennungsmotor  
 RU Диффузионный бензиновый опрыскиватель  
 CZ Motorový zádový postřikovač  
 SK Motorova chrbtovú postrekovač  
 HU Robbanómotoros hátí permetezőgépek  
 RO Dispozitiv pt. stropit cu combustibil purtat in spate



5901477140501

**Opryskiwacz spalinowy 20L** H00662 1

GB Diffusion gasoline sprinkler  
 DE Ruckenspritze mit Verbrennungsmotor  
 RU Диффузионный бензиновый опрыскиватель  
 CZ Motorový zádový postřikovač  
 SK Motorova chrbtovú postrekovač  
 HU Robbanómotoros hátí permetezőgépek  
 RO Dispozitiv pt. stropit cu combustibil purtat in spate



5901477140518

**Opryskiwacz spalinowy 26L** H00663 1

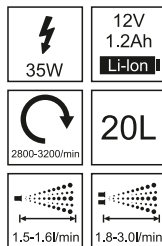
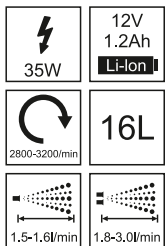

GB Battery sprayer  
 DE Batterie Sprayer  
 RU Опрыскиватель батареи  
 CZ Ruční tlakový postřikovač  
 SK Ručný tlakový postrekovač  
 HU Permetező kézi  
 RO Vermorel



5901477124457

**Opryskiwacz akumulatorowy 16L** G73215 1

GB Battery sprayer  
 DE Batterie Sprayer  
 RU Опрыскиватель батареи  
 CZ Ruční tlakový postřikovač  
 SK Ručný tlakový postrekovač  
 HU Permetező kézi  
 RO Vermorel



5901477124464

**Opryskiwacz akumulatorowy 20L** G73216 1

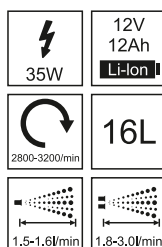
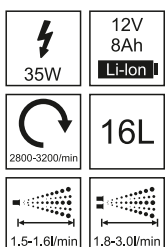

GB Battery sprayer  
 DE Batterie Sprayer  
 RU Опрыскиватель батареи  
 CZ Ruční tlakový postřikovač  
 SK Ručný tlakový postrekovač  
 HU Permetező kézi  
 RO Vermorel



5901477157912

**Opryskiwacz akumulatorowy plecakowy 16L Lekki** G73251 1

GB Battery sprayer  
 DE Batterie Sprayer  
 RU Опрыскиватель батареи  
 CZ Ruční tlakový postřikovač  
 SK Ručný tlakový postrekovač  
 HU Permetező kézi  
 RO Vermorel



5901477157929

**Opryskiwacz akumulatorowy plecakowy 16L Lekki Blue** G73252 1



16L 48cm



16L 48cm



GB Pressure sprayer  
DE Drucksprüher  
RU Ручной опрыскиватель  
CZ Ruční tlakový postřikovač  
SK Ručný tlakový postrekoč  
HU Permetező kézi  
RO Vermorel



Kod EAN  
5901477100611

**Opryskiwacz 18L** Kod produktu **G73204** 1

GB Pressure sprayer  
DE Drucksprüher  
RU Ручной опрыскиватель  
CZ Ruční tlakový postřikovač  
SK Ručný tlakový postrekoč  
HU Permetező kézi  
RO Vermorel



Kod EAN  
5901477100628

**Opryskiwacz 16l (niebieski)** Kod produktu **G73205** 1

12L 48cm



2L



GB Pressure sprayer  
DE Drucksprüher  
RU Ручной опрыскиватель  
CZ Ruční tlakový postřikovač  
SK Ručný tlakový postrekoč  
HU Permetező kézi  
RO Vermorel



Kod EAN  
5901477124495

**Opryskiwacz plecakowy 12L** Kod produktu **G73214** 1

GB Pressure sprayer  
DE Drucksprüher  
RU Ручной опрыскиватель  
CZ Ruční tlakový postřikovač  
SK Ručný tlakový postrekoč  
HU Permetező kézi  
RO Vermorel



Kod EAN  
5901477100581

**Opryskiwacz 2l** Kod produktu **G73201** 20

5L 43cm



8L 43cm



GB Pressure sprayer  
DE Drucksprüher  
RU Ручной опрыскиватель  
CZ Ruční tlakový postřikovač  
SK Ručný tlakový postrekoč  
HU Permetező kézi  
RO Vermorel



Kod EAN  
5901477100598

**Opryskiwacz 5l** Kod produktu **G73202** 6

GB Pressure sprayer  
DE Drucksprüher  
RU Ручной опрыскиватель  
CZ Ruční tlakový postřikovač  
SK Ručný tlakový postrekoč  
HU Permetező kézi  
RO Vermorel



Kod EAN  
5901477100604

**Opryskiwacz 8l** Kod produktu **G73203** 6

1.5L



GB Pressure sprayer  
DE Drucksprüher  
RU Ручной опрыскиватель  
CZ Ruční tlakový postřikovač  
SK Ručný tlakový postrekovač  
HU Permetező kézi  
RO Vermorel



**Opryskiwacz ciśnieniowy 1,5L z regulowaną dyszą**    Kod produktu: G73231    15

8L



GB Pressure sprayer  
DE Drucksprüher  
RU Ручной опрыскиватель  
CZ Ruční tlakový postřikovač  
SK Ručný tlakový postrekovač  
HU Permetező kézi  
RO Vermorel



**Opryskiwacz SX-8 do chemii agresywnej 8L**    Kod produktu: G73232    6

16L



GB Pressure sprayer  
DE Drucksprüher  
RU Ручной опрыскиватель  
CZ Ruční tlakový postřikovač  
SK Ručný tlakový postrekovač  
HU Permetező kézi  
RO Vermorel



**Opryskiwacz ciśnieniowy na kołach 16L**    Kod produktu: G73233    2

5L



GB Pressure sprayer  
DE Drucksprüher  
RU Ручной опрыскиватель  
CZ Ruční tlakový postřikovač  
SK Ručný tlakový postrekovač  
HU Permetező kézi  
RO Vermorel



**Opryskiwacz ciśnieniowy 5L ORANGE**    Kod produktu: G73235    6

8L



GB Pressure sprayer  
DE Drucksprüher  
RU Ручной опрыскиватель  
CZ Ruční tlakový postřikovač  
SK Ručný tlakový postrekovač  
HU Permetező kézi  
RO Vermorel



**Opryskiwacz ciśnieniowy 8L ORANGE**    Kod produktu: G73238    6

0.75L



GB Pressure sprayer  
DE Drucksprüher  
RU Ручной опрыскиватель  
CZ Ruční tlakový postřikovač  
SK Ručný tlakový postrekovač  
HU Permetező kézi  
RO Vermorel



**Opryskiwacz ręczny 0,75L**    Kod produktu: G73255    100



3L 43cm



GB Pressure sprayer  
DE Drucksprüher  
RU Ручной опрыскиватель  
CZ Ruční tlakový postřikovač  
SK Ručný tlakový postrekovač  
HU Permetező kézi  
RO Vermorel



5901477165726

John Gardener Kod produktu 6  
Opryskiwacz ciśnieniowy ręczny 3L G73256

5L 43cm



GB Pressure sprayer  
DE Drucksprüher  
RU Ручной опрыскиватель  
CZ Ruční tlakový postřikovač  
SK Ručný tlakový postrekovač  
HU Permetező kézi  
RO Vermorel



5901477165733

John Gardener Kod produktu 6  
Opryskiwacz ciśnieniowy ręczny 5L G73257

1L



GB Pressure sprayer  
DE Drucksprüher  
RU Ручной опрыскиватель  
CZ Ruční tlakový postřikovač  
SK Ručný tlakový postrekovač  
HU Permetező kézi  
RO Vermorel



5901477170553

John Gardener Kod produktu 20  
Opryskiwacz ciśnieniowy 1L G73265

3L



GB Pressure sprayer  
DE Drucksprüher  
RU Ручной опрыскиватель  
CZ Ruční tlakový postřikovač  
SK Ručný tlakový postrekovač  
HU Permetező kézi  
RO Vermorel



5901477170560

John Gardener Kod produktu 20  
Opryskiwacz ciśnieniowy 3L G73266

350mm



GB Pressure sprayer  
DE Drucksprüher  
RU Ручной опрыскиватель  
CZ Ruční tlakový postřikovač  
SK Ručný tlakový postrekovač  
HU Permetező kézi  
RO Vermorel



5901477173479

John Gardener Kod produktu 100  
Opryskiwacz ciśnieniowy na butelkę (mosiężny) G73267

44cm



GB Lance and the handle for sprayer  
DE Lanze und der Griff für Sprayer  
RU Копье и ручка для опрыскивателя  
CZ Nástavec postřikovače  
SK Nástavec postrekovače  
HU Lándzsa  
RO Lance



5901477100642

John Gardener Kod produktu 1  
Lanca do opryskiwaczy 5L i 8L 44cm G73207

55.5cm



GB Lance and the handle for sprayer  
DE Lanze und der Griff für Sprayer  
RU Копье и ручка для опрыскивателя  
CZ Nástavec postřikovače  
SK Nástavec postrekovače  
HU Lándzsa  
RO Lance



5901477157295

John Gardener Kod produktu 1  
Lanca i rączka do opryskiwaczy 5L i 8L G73213A

58-100cm



GB Telescopic handle  
DE Teleskoplanze  
RU Штанга телескопическая для опрыскивателя  
CZ Násadec teleskopický  
SK Násadec teleskopický  
HU Teleszkópos lándzsa  
RO Maner telescopic



5901477100659

John Gardener Kod produktu 1  
Lanca teleskopowa 58cm-100cm stalowa G73208



GB Shower spray gun  
DE Spritzpistole  
RU Пистолет для опрыскивателей  
CZ Rozprašovaci pistole na vodu  
SK Rozprašovacia pištoľ na vodu  
HU Locsoló pisztoly  
RO Pistol pt. stropit

Kod EAN  
5901477100673

John Gardener Kod produktu  
**Rączka do lancy S-04** G73210 1



GB Telescopic handle  
DE Teleskoplanze  
RU Штанга телескопическая для опрыскивателя  
CZ Násadec teleskopický  
SK Násadec teleskopický  
HU Teleszkópos lándzsa  
RO Maner telescopic

50-250cm

Kod EAN  
5901477140563

John Gardener Kod produktu  
**Lanca teleskopowa 50-250cm do opryskiwaczy** G73244 100

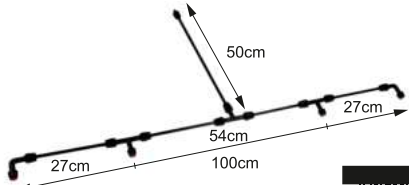

GB Lance  
DE Lanze  
RU Копьё  
CZ Nástavec postřikovače  
SK Nástavec postrekovače  
HU Lándzsa  
RO Lance

50cm  
27cm  
54cm  
100cm  
27cm

Kod EAN  
5901477140525

John Gardener Kod produktu  
**Lanca opryskiwacza długa - 4 dysze** G73240 100



GB Lance  
DE Lanze  
RU Копьё  
CZ Nástavec postřikovače  
SK Nástavec postrekovače  
HU Lándzsa  
RO Lance

90cm

Kod EAN  
5901477140532

John Gardener Kod produktu  
**Lanca opryskiwacza ciśnieniowego długa 90cm** G73241 150



GB Telescopic handle  
DE Teleskoplanze  
RU Штанга телескопическая для опрыскивателя  
CZ Násadec teleskopický  
SK Násadec teleskopický  
HU Teleszkópos lándzsa  
RO Maner telescopic

36cm

Kod EAN  
5901477140549

John Gardener Kod produktu  
**Lanca mosiężna opryskiwacza ciśnieniowego 5-8L** G73242 200



GB Lance and the handle for sprayer  
DE Lanze und der Griff für Sprayer  
RU Копьё и ручка для опрыскивателя  
CZ Nástavec postřikovače  
SK Nástavec postrekovače  
HU Lándzsa  
RO Lance

50cm

Kod EAN  
5901477140556

John Gardener Kod produktu  
**Lanca metalowa opryskiwacza ciśnieniowego +rączka** G73243 150



GB Straight nozzle for pressure sprayer  
DE Sprühdüse für Drucksprüher  
RU Распылитель на опрыскиватели  
CZ Rozprašovaci koncovka k postřikovači  
SK Rozprašovacia koncovka k postrekovačmi  
HU Porlasztó tömlővég eszételőhöz  
RO Doza pt. vermoresl

3pcs

Kod EAN  
5901477165917

John Gardener Kod produktu  
**3szt. dysz do opryskiwacza akumulatorowego** G73245 250



GB Herbicide shield  
DE Sprühdeckel  
RU Крышка распылителя  
CZ Kryt postřikovače  
SK Kryt postrekovača  
HU Permetező szűkítő tölsér  
RO Palnie pentru erbicidat

Kod EAN  
5901477157301

John Gardener Kod produktu  
**Ośłona herbicydowa opryskiwacza** G73246 200



GB Weed burner  
DE Unkrautbrenner  
RU Горелка сорняков  
CZ Vypalovač plevelu  
SK Vypalovaciač buriny  
HU Kézi gyomégető  
RO Arzator de buruieni

1300°C  
15cm  
80cm

Kod EAN  
5901477155017

EKO Kod produktu  
**Palnik-wypalarka ogrodowa do chwastów** G20035 12



GB Weed burner  
DE Unkrautbrenner  
RU Горелка сорняков  
CZ Vypalovač plevelu  
SK Vypalovaciač buriny  
HU Kézi gyomégető  
RO Arzator de buruieni

230V-50Hz  
2500W  
50-600°C

Kod EAN  
5901477155024

EKO Kod produktu  
**Opalarka - wypalarka do chwastów 230V** G20036 10



# Pompy do wody / Water Pumps



⚡ 6.5KM  
3"

MAX 3600/min  
max 1000 l/min



⚡ 1.9KM  
1"

MAX 7000/min  
max 400 l/min



GB Gasoline water pump  
DE Pumpe mit verbrennungsmotor  
RU Бензонасос  
CZ Čerpadlo se spalovacím motorem  
SK Čerpadlo so spaľovacím motorom  
HU Robbanómotoros szivattyú  
RO Pompa cu motor cu ardere internă



GB Gasoline water pump  
DE Pumpe mit verbrennungsmotor  
RU Бензонасос  
CZ Čerpadlo se spalovacím motorem  
SK Čerpadlo so spaľovacím motorom  
HU Robbanómotoros szivattyú  
RO Pompa cu motor cu ardere internă



**EKO** Pompa spalinowa do wody, motopompa 3" **G81040** 1

**EKO** Pompa spalinowa do wody, motopompa 1" **G81041** 1

⚡ 6.5KM  
2"

MAX 3600/min  
max 600 l/min



9 Teeth  
Diameter: 28mm



GB Gasoline water pump  
DE Pumpe mit verbrennungsmotor  
RU Бензонасос  
CZ Čerpadlo se spalovacím motorem  
SK Čerpadlo so spaľovacím motorom  
HU Robbanómotoros szivattyú  
RO Pompa cu motor cu ardere internă



GB Water pump - adaptor for brush cutter  
DE Wasserpumpe - Adapter für Freischneider  
RU Водяной насос - адаптер для кусторезов  
CZ Vodní pumpa - adaptér na křovinořez  
SK Vodná pumpa - adaptér na křovinořez  
HU Vízpumpa - adapter bozótvágohoz  
RO Pompa de apa - adaptor pentru motocosita



**EKO** Pompa spalinowa do wody, motopompa 2" **G81042** 1

**EKO** Pompa do wody – przystawka do kosy spalinowej **G81064D** 20

Wydajność: <b>30</b> m³/h	Obroty na min: <b>3600</b> RPM
Króćce przyłączeniowe: <b>2"</b> (50mm)	Wysokość podnoszenia: <b>36</b> m



GB Belt-driven Transfer Water Pump  
DE Riemengetriebene Transferwasserpumpe  
RU Перекачивающий водяной насос с ремённым приводом  
CZ Převodní vodní čerpadlo poháněné řemenem  
SK Prevodové vodné čerpadlo poháňané remeňom  
HU Szíjhajtású transzfer vízszivattyú  
RO Pompă de apă de transfer acţionată de curea



**GEKO** Kod produktu **G81467** 1  
**Pompa do wody na pasek klinowy, motopompa 2"**

Wydajność: <b>55</b> m³/h	Obroty na min: <b>3600</b> RPM
Króćce przyłączeniowe: <b>3"</b> (75mm)	Wysokość podnoszenia: <b>36</b> m



GB Gasoline water pump  
DE Pumpe mit verbrennungsmotor  
RU Бензонасос  
CZ Čerpadlo se spalovacím motorem  
SK Čerpadlo so spaľovacím motorom  
HU Robbanómotoros szivattyú  
RO Pompa cu motor cu ardere internă



**GEKO** Kod produktu **G81468** 1  
**Pompa do wody na pasek klinowy, motopompa 3"**

Wydajność: <b>80</b> m³/h	Obroty na min: <b>3600</b> RPM
Króćce przyłączeniowe: <b>4"</b> (100mm)	Wysokość podnoszenia: <b>36</b> m



GB Belt-driven Transfer Water Pump  
DE Riemengetriebene Transferwasserpumpe  
RU Перекачивающий водяной насос с ремённым приводом  
CZ Převodní vodní čerpadlo poháněné řemenem  
SK Prevodové vodné čerpadlo poháňané remeňom  
HU Szíjhajtású transzfer vízszivattyú  
RO Pompă de apă de transfer acţionată de curea



**GEKO** Kod produktu **G81469** 1  
**Pompa do wody na pasek klinowy, motopompa 4"**

230V-50Hz	400W
max 5.0 m³/h	1" 1-1/4" 1-1/2"



GB Dirty water submersible pump  
DE Tauchmotorpumpe  
RU Погружной насос  
CZ Zatavovací čerpadlo  
SK Zatašovacie čerpadlo  
HU Bűvárszivattyú  
RO Pompă pt. apă murdară



**GEKO** Kod produktu **G81401** 1  
**Pompa plastik z pływakiem do brudnej wody**

230V-50Hz	550W
max 17000 l/h	2"
żeliwo	↑ max 8m



GB Submersible pump for dirty water and wastewater  
DE Tauchpumpe für Schmutzwasser  
RU Погружной насос для грязной воды  
CZ Ponorné čerpadlo pro odpadní vody  
SK Ponorné čerpadlo pre odpadové vody  
HU Bűvárszivattyú szennyvíz  
RO Pompă submersibilă pt. apă uzată



**GEKO** Kod produktu **G81402** 1  
**Pompa rozdr. WQD 10-8-0,55 do brudnej wody/czarna/**

230V-50Hz	370W
max 6000 l/h	1"
żeliwo	



GB Water pump (Cast iron)  
DE Wasserpumpe (Gusseisen)  
RU Гидроструйный насос (Чугун)  
CZ Ponorná čerpadla  
SK Ponorné čerpadlá  
HU Mélykútszivattyú  
RO Pompa apa submersibila



**GEKO** Kod produktu **G81403** 1  
**Pompa do wody QDX 0,37 GEKO żeliwo**



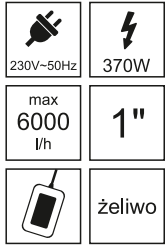

GB Water pump (Cast iron)  
DE Wasserpumpe (Gusseisen)  
RU Гидроструйный насос (Чугун)  
CZ Ponorňá erpadla  
SK Ponorňné erpadl  
HU Mlyktszivatty  
RO Pompa apa submersibila



**Pompa do wody QDX3-0.37 GEKO eliwo z plywakciem G81405 1**

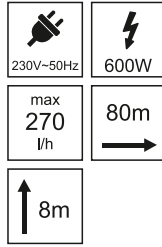

GB WC sewage pump  
DE WC Abwasserpumpe  
RU WC насос для сточных вод  
CZ WC erpadlo  
SK WC erpadlo  
HU Darls WC s hztartsi viztemel  
RO Pompa pentru ape uzate



**Pompa do przepompowywania w WC z rozdrabniaczem G81419 1**



GB Submersible pump for dirty water and wastewater  
DE Tauchpumpe fur Schmutzwasser  
RU Погружной насос для грязной воды  
CZ Ponorňné erpadlo pro odpadn vodu  
SK Ponorňné erpadlo pre odpadov vodu  
HU Bvrszivatty szennyvz  
RO Pomp submersibil pt. ap uzat



**Pompa rozdr. WQD10-8-0.55 z plywakciem/do brudnej wody/ G81420 1**

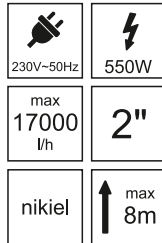

GB Dirty water submersible pump  
DE Tauchmotorpumpe  
RU Погружной насос  
CZ Zatahovci erpadlo  
SK Zatahovacie erpadlo  
HU Bvrszivatty  
RO Pomp pt. ap murdar



**Pompa rozdr. WQD 10-8-0,55 nikel/do brudnej wody G81421 1**



GB Submersible pump for dirty water and wastewater  
DE Tauchpumpe fur Schmutzwasser  
RU Погружной насос для грязной воды  
CZ Ponorňné erpadlo pro odpadn vodu  
SK Ponorňné erpadlo pre odpadov vodu  
HU Bvrszivatty szennyvz  
RO Pomp submersibil pt. ap uzat



**Pompa rozdrabniacz z noami tncymi G81423 1**

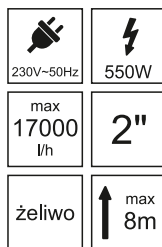

GB Dirty water submersible pump  
DE Tauchmotorpumpe  
RU Погружной насос  
CZ Zatahovci erpadlo  
SK Zatahovacie erpadlo  
HU Bvrszivatty  
RO Pomp pt. ap murdar



**Pompa rozdrab. WQD-10-8-0,55 do brudnej wody G81424 1**



max 20000 l/h	2"



max 17000 l/h	2"
	↑ max 8m



GB Submersible pump for dirty water and wastewater  
 DE Tauchpumpe für Schmutzwasser  
 RU Погружной насос для грязной воды  
 CZ Ponorné čerpadlo pro odpadní vody  
 SK Ponorné čerpadlo pre odpadové vody  
 HU Búvárszivattyú szennyvíz  
 RO Pompă submersibilă pt. apă uzată



Kod EAN  
5901477125508

**Pompa do ścieków WQCD 0,75 z rozdrabniaczem(miedz, uzw.) G81425 1**

GB Dirty water submersible pump  
 DE Tauchmotorpumpe  
 RU Погружной насос  
 CZ Zatavovací čerpadlo  
 SK Zatavovacie čerpadlo  
 HU Búvárszivattyú  
 RO Pompă pt. apă murdară



Kod EAN  
5901477126031

**Pompa do szamba WQD-nikiel pływak+wylącznik termiczny G81426 1**

max 17000 l/h	2"
	żeliwo
↑ max 8m	



max 17000 l/h	2"
	nikiel
↑ max 8m	



GB Submersible pump for dirty water and wastewater  
 DE Tauchpumpe für Schmutzwasser  
 RU Погружной насос для грязной воды  
 CZ Ponorné čerpadlo pro odpadní vody  
 SK Ponorné čerpadlo pre odpadové vody  
 HU Búvárszivattyú szennyvíz  
 RO Pompă submersibilă pt. apă uzată



Kod EAN  
5901477126024

**Pompa do szamba WQD-rozdra. pływak+wylącznik termiczny G81427 1**

GB Dirty water submersible pump  
 DE Tauchmotorpumpe  
 RU Погружной насос  
 CZ Zatavovací čerpadlo  
 SK Zatavovacie čerpadlo  
 HU Búvárszivattyú  
 RO Pompă pt. apă murdară



Kod EAN  
5901477123313

**Pompa rozdr. WQD10-8-0,55 nikiel z pływakiem/do brudnej wody/ G81428 1**

max 17000 l/h	2"
	↑ max 8m
żeliwo	



max 167 l/m	1"
	↑ max 8.5m
nikiel /żeliwo	



GB Submersible pump for dirty water and wastewater  
 DE Tauchpumpe für Schmutzwasser  
 RU Погружной насос для грязной воды  
 CZ Ponorné čerpadlo pro odpadní vody  
 SK Ponorné čerpadlo pre odpadové vody  
 HU Búvárszivattyú szennyvíz  
 RO Pompă submersibilă pt. apă uzată



Kod EAN  
5901477152726

**Pompa do szamba z rozdr. WQD-055 + pływak G81429 1**



GB Dirty water submersible pump  
 DE Tauchmotorpumpe  
 RU Погружной насос  
 CZ Zatavovací čerpadlo  
 SK Zatavovacie čerpadlo  
 HU Búvárszivattyú  
 RO Pompă pt. apă murdară





Kod EAN  
5901477148996

**Pompa do szamba WQD3-7-0.25 + pływak PREMIUM G81440 1**



 230V-50Hz	 550W
max 317 l/m	2"
	↑ max 14m
nikiel /żeliwo	



 230V-50Hz	 750W
max 334 l/m	2"
	↑ max 14.5m
nikiel /żeliwo	



GB Dirty water submersible pump  
DE Tauchmotorpumpe  
RU Погружной насос  
CZ Zatavovací čerpadlo  
SK Zatahovacie čerpadlo  
HU Búvárszivattyú  
RO Pompă pt. apă murdară

Kod EAN



5901477148958

 Pompa do szamba WQD8-8-0.55 PREMIUM Kod produktu  G81441 1



GB Dirty water submersible pump  
DE Tauchmotorpumpe  
RU Погружной насос  
CZ Zatavovací čerpadlo  
SK Zatahovacie čerpadlo  
HU Búvárszivattyú  
RO Pompă pt. apă murdară

Kod EAN



5901477148965

 Pompa do szamba WQD10-10-0.75 z plywakiem PREMIUM Kod produktu  G81442 1

 230V-50Hz	 1100W
max 284 l/m	2"
	↑ max 16.5m
nikiel /żeliwo	







GB Dirty water submersible pump  
DE Tauchmotorpumpe  
RU Погружной насос  
CZ Zatavovací čerpadlo  
SK Zatahovacie čerpadlo  
HU Búvárszivattyú  
RO Pompă pt. apă murdară

Kod EAN



5901477148972

 Pompa do szamba z mlynkiem 1.1KW PREMIUM Kod produktu  G81445 1

 230V-50Hz	 1500W
max 384 l/m	2"
	↑ max 17.5m
nikiel /żeliwo	







GB Dirty water submersible pump  
DE Tauchmotorpumpe  
RU Погружной насос  
CZ Zatavovací čerpadlo  
SK Zatahovacie čerpadlo  
HU Búvárszivattyú  
RO Pompă pt. apă murdară

Kod EAN



5901477148989

 Pompa do szamba z mlynkiem 1.5KW PREMIUM Kod produktu  G81446 1

 230V-50Hz	 400W
max 7500 l/h	1" 1-1/4" 1-1/2"
	↑ max 5m







GB Dirty water submersible pump  
DE Tauchmotorpumpe  
RU Погружной насос  
CZ Zatavovací čerpadlo  
SK Zatahovacie čerpadlo  
HU Búvárszivattyú  
RO Pompă pt. apă murdară

Kod EAN



5901477148934

 Pompa plastik do brudnej wody z plywakiem typ.2 Kod produktu  G81453 4

 230V-50Hz	 750W
max 13000 l/h	1" 1-1/4" 1-1/2"
	↑ max 9m



GB Dirty water submersible pump  
DE Tauchmotorpumpe  
RU Погружной насос  
CZ Zatavovací čerpadlo  
SK Zatahovacie čerpadlo  
HU Búvárszivattyú  
RO Pompă pt. apă murdară

Kod EAN



5901477148941

 Pompa Plastik do brudnej wody 750W z plywakiem BIG Kod produktu  G81454 4

max 15000 l/h	1" 1-1/4" 1-1/2"
	max 10m



max 13000 l/h	1" 1-1/4" 1-1/2"
	max 9m



GB Dirty water submersible pump  
DE Tauchmotorpumpe  
RU Погружной насос  
CZ Zatavovací čerpadlo  
SK Zatahovacie čerpadlo  
HU Búvárszivattyú  
RO Pompă pt. apă murdară



Kod EAN  
5901477169694

**Pompa plastik do brudnej wody 1100W**      Kod produktu **G81457**      4

GB Dirty water submersible pump  
DE Tauchmotorpumpe  
RU Погружной насос  
CZ Zatavovací čerpadlo  
SK Zatahovacie čerpadlo  
HU Búvárszivattyú  
RO Pompă pt. apă murdară



Kod EAN  
5901477173394

**Pompa plastik do brudnej wody z wbudowanym pływakiem**      Kod produktu **G81459**      4

max 6000 l/h	1" 1-1/4" 1-1/2"
	max 7m



max 14000 l/h	1" 1-1/4" 1-1/2"
	max 9m



GB Dirty water submersible pump  
DE Tauchmotorpumpe  
RU Погружной насос  
CZ Zatavovací čerpadlo  
SK Zatahovacie čerpadlo  
HU Búvárszivattyú  
RO Pompă pt. apă murdară



Kod EAN  
5901477180279

**Pompa płytkossąca do czystej wody z wyłącznikiem elektrodowym**      Kod produktu **G81462**      4

GB Dirty water submersible pump  
DE Tauchmotorpumpe  
RU Погружной насос  
CZ Zatavovací čerpadlo  
SK Zatahovacie čerpadlo  
HU Búvárszivattyú  
RO Pompă pt. apă murdară



Kod EAN  
5901477180286

**Pompa zanurzeniowa z pływakiem do brudnej wody**      Kod produktu **G81463**      4

max 17000 l/h	max 8m



max 17000 l/h	
max 8m	



GB Dirty water submersible pump  
DE Tauchmotorpumpe  
RU Погружной насос  
CZ Zatavovací čerpadlo  
SK Zatahovacie čerpadlo  
HU Búvárszivattyú  
RO Pompă pt. apă murdară



Kod EAN  
5901477123573

**Pompa do brudnej wody szamba WQD Nikiel**      Kod produktu **H00606**      1

GB Dirty water submersible pump  
DE Tauchmotorpumpe  
RU Погружной насос  
CZ Zatavovací čerpadlo  
SK Zatahovacie čerpadlo  
HU Búvárszivattyú  
RO Pompă pt. apă murdară



Kod EAN  
5901477123153

**Pompa do szamba z rozdrabniaczem WQD NIKIEL z pływakiem**      Kod produktu **H00607**      1





GB Dirty water submersible pump  
DE Tauchmotorpumpe  
RU Погружной насос  
CZ Zatavnací čerpadlo  
SK Zátavnacie čerpadlo  
HU Bűvárszivattyú  
RO Pompă pt. apă murdară



Kod EAN  
5901477127885

Heidmann Kod produktu  
**Pompa rozdrabiacz z nożami tnącymi typ H H00610 1**

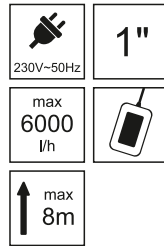

GB Water pump (Cast iron)  
DE Wasserpumpe (Gusseisen)  
RU Гидроструйный насос (Чугун)  
CZ Ponorná čerpadla  
SK Ponorné čerpadlá  
HU Mélykútszivattyú  
RO Pompa apa submersibila



Kod EAN  
5901477143687

Heidmann Kod produktu  
**Pompa do wody QDX "Sito" Heidmann H00614 1**



GB Float switch for WQD10-8-055  
DE Schwimmerschalter für Tauchpumpe  
RU Поплавковый выключатель  
CZ Plovací spínač  
SK Plávajúce spínač  
HU Úszókapcsoló  
RO Comutator plutitor



Kod EAN  
5901477165924

EKO Kod produktu  
**Pływak do pompy rozdrabiacz WQD 10-8-0,55(G81420) G81449 100**



GB Body for WQD10-8-055  
DE Pumpengehäuse für Tauchpumpe  
RU Крышка  
CZ Kryt čerpadla  
SK Kryt čerpadla  
HU Szivattyúház  
RO Carcasa pompa



Kod EAN  
5901477167027

EKO Kod produktu  
**Obudowa do pompy rozdrabiacz WQD 10-8-0,55 G81449A 10**



GB Basis  
DE Pumpenfußplatte  
RU Плита основания  
CZ Náhradní podstavec čerpadla  
SK Náhradné podstavec čerpadla  
HU Szivattyú láb  
RO Baza pompei



Kod EAN  
5901477167034

EKO Kod produktu  
**Podstawa do pompy rozdrabiacz WQD 10-8-0,55 G81449B 10**



GB Basis for WQD 10-8-0,55  
DE Pumpenfußplatte  
RU Плита основания  
CZ Základna čerpadla  
SK Základňa čerpadla  
HU Szivattyú láb  
RO Baza pompei



Kod EAN  
5901477167041

EKO Kod produktu  
**Podstawa do pompy nikiel WQD 10-8-0,55 G81449C 25**



GB Gaskets, rubber bands  
DE Flachdichtungen, gummi bände  
RU Уплотняющая прокладка, резинка  
CZ Těsnění, pryžové pásky  
SK Tesnenie, gumené pásky  
HU Csúszótömítés  
RO Garnituri, benzi de cauciuc



Kod EAN  
5901477167058

EKO Kod produktu  
**Uszczelniacze, recepturki do pomp WQD 10-8-0,55 G81449D 100**



GB Capacitor WQD  
DE Kondensator für Tauchpumpe  
RU Конденсатор  
CZ Kondenzátor  
SK Kondenzátor  
HU Kondenzátor  
RO Condensator



Kod EAN  
5901477167065

EKO Kod produktu  
**Kondensator do pompy rozdrabiacz WQD 10-8-0,55 G81449E 100**







GB Power cord  
DE Netzkabel  
RU Шнур питания  
CZ Napájecí kabel  
SK Napájací kábel  
HU Tápkábel  
RO Cablu de alimentare



Kod EAN  
5901477165931

EKO Kod produktu  
**Przewód zasilający do pompy z rozdrabiaczem G81449F 25**

 230V-50Hz	 0.4kW
max 65 l/min	1"
 2800/min	max 26m
 95mm	



 230V-50Hz	 0.6kW
max 60 l/min	1.5"
 2800/min	max 42m
 95mm	



GB Water pump  
DE Unterwasserpumpe  
RU Погружной насос  
CZ Ponorná čerpadla  
SK Ponorné čerpadlá  
HU Mélykútszivattyú  
RO Pompa apa submersibila

Kod EAN



5901477115547

 **Pompa głębinowa QJD-26/6-0,4** Kod produktu **G81406**  **1**



GB Water pump  
DE Unterwasserpumpe  
RU Погружной насос  
CZ Ponorná čerpadla  
SK Ponorné čerpadlá  
HU Mélykútszivattyú  
RO Pompa apa submersibila

Kod EAN





5901477115035

 **Pompa głębinowa QJD2-42/10-0,6** Kod produktu **G81408**  **1**

 230V-50Hz	 1.1kW
max 90 l/min	1.5"
 2800/min	max 62m
 95mm	



 230V-50Hz	 1.5kW
max 90 l/min	1.5"
 2800/min	max 62m
 95mm	



GB Water pump  
DE Unterwasserpumpe  
RU Погружной насос  
CZ Ponorná čerpadla  
SK Ponorné čerpadlá  
HU Mélykútszivattyú  
RO Pompa apa submersibila

Kod EAN



5901477114991

 **Pompa głębinowa QJD2-62/15-1.1** Kod produktu **G81409**  **1**





GB Water pump  
DE Unterwasserpumpe  
RU Погружной насос  
CZ Ponorná čerpadla  
SK Ponorné čerpadlá  
HU Mélykútszivattyú  
RO Pompa apa submersibila

Kod EAN





5901477114083

 **Pompa głębinowa QJD2-62/15-1,5** Kod produktu **G81410**  **1**

 230V-50Hz	 0.75kW
max 55 l/min	1"
 2800/min	max 100m
 100mm	



 230V-50Hz	 280W
max 0.9 m <sup>3</sup> /h	3/4"
max 16m	



GB Water pump  
DE Unterwasserpumpe  
RU Погружной насос  
CZ Ponorná čerpadla  
SK Ponorné čerpadlá  
HU Mélykútszivattyú  
RO Pompa apa submersibila

Kod EAN



5901477125492

 **Pompa głębinowa śrubowa 750W** Kod produktu **G81417**  **1**

GB Membrane deep well water pump  
DE Tauchmotorpumpe  
RU Погружных насос  
CZ Zataovací čerpadlo  
SK Zatavovacie čerpadlo  
HU Búvárszivattyú  
RO Pompa pt. apa cu membrana



Kod EAN





5901477166617

 **Pompa głębinowa do wody (typ nurek)** Kod produktu **G81414**  **6**



 230V-50Hz	 460W
max 1080 l/h	3/4"
↑ max 60m	



 230V-50Hz	 280W
max 0.9 m³/h	3/4"
↑ max 60m	



GB Membrane deep well water pump  
DE Tauchmotorpumpe  
RU Погружной насос  
CZ Zataňovací řerpadlo  
SK Zataňovacie řerpadlo  
HU Bűvárszivattyű  
RO Pompa pt. apa cu membrana

Kod EAN



5901477128837

**Keldmann** Kod produktu   
**Pompa gűbiniowa VMP60 typ. nurek** H00611 6



GB Membrane deep well water pump  
DE Tauchmotorpumpe  
RU Погружной насос  
CZ Zataňovací řerpadlo  
SK Zataňovacie řerpadlo  
HU Bűvárszivattyű  
RO Pompa pt. apa cu membrana

Kod EAN







5901477125515

**EKO** Kod produktu   
**Pompa do wody nurek dolnosřacy** G81422 6

 230V-50Hz	 280W
max 1.08 m³/h	3/4"
↑ max 60m	



 230V-50Hz	 1100W
 3450/min	 60l/min



GB Membrane deep well water pump  
DE Tauchmotorpumpe  
RU Погружной насос  
CZ Zataňovací řerpadlo  
SK Zataňovacie řerpadlo  
HU Bűvárszivattyű  
RO Pompa pt. apa cu membrana

Kod EAN



5901477153389

**EKO** Kod produktu   
**Pompa gűbiniowa typu nurek gűrnosřaca PREMIUM** G81455 6





GB Self-priming pump  
DE Selbstansaugende Pumpe  
RU Самовсасывающий насос  
CZ Samonasřavací řerpadlo  
SK Samonasřavacie řerpadlo  
HU Őnfelszivű szivattyű  
RO Pompă de auto-amorsare

Kod EAN







5901477136450

**EKO** Kod produktu   
**Pompa hydroforowa JET100S 1100W** G81500 1

 230V-50Hz	 1100W
 3450/min	 60l/min



 230V-50Hz	 1100W
 3450/min	 60l/min

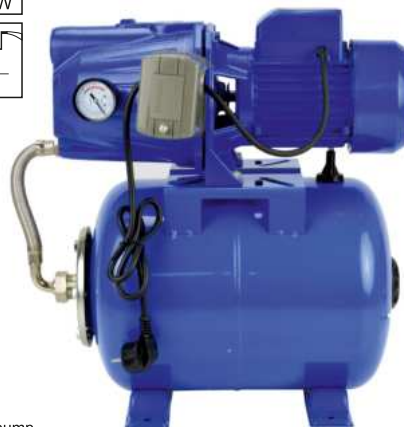

GB Self-priming pump  
DE Selbstansaugende Pumpe  
RU Самовсасывающий насос  
CZ Samonasřavací řerpadlo  
SK Samonasřavacie řerpadlo  
HU Őnfelszivű szivattyű  
RO Pompă de auto-amorsare

Kod EAN



5901477136467

**EKO** Kod produktu   
**Pompa hydroforowa JS100 1100W** G81501 1

GB Self-priming pump  
DE Selbstansaugende Pumpe  
RU Самовсасывающий насос  
CZ Samonasřavací řerpadlo  
SK Samonasřavacie řerpadlo  
HU Őnfelszivű szivattyű  
RO Pompă de auto-amorsare

Kod EAN



5901477139468

**EKO** Kod produktu   
**Zestaw hydroforowy 24L JET100S** G81511 1

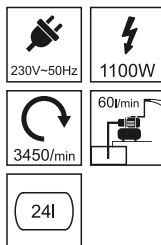
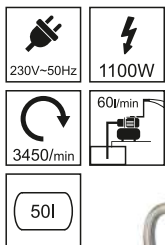

GB Self-priming pump  
DE Selbstansaugende Pumpe  
RU Самовсасывающий насос  
CZ Samonasávací čerpadlo  
SK Samonasávacie čerpadlo  
HU Önfelszívó szivattyú  
RO Pompă de auto-amorsare



Kod EAN  
5901477139475

**Zestaw hydroforowy 50l JET100S**      Kod produktu      G81512      1

GB Self-priming pump  
DE Selbstansaugende Pumpe  
RU Самовсасывающий насос  
CZ Samonasávací čerpadlo  
SK Samonasávacie čerpadlo  
HU Önfelszívó szivattyú  
RO Pompă de auto-amorsare



Kod EAN  
5901477139482

**Zestaw hydroforowy 24L Js100**      Kod produktu      G81513      1

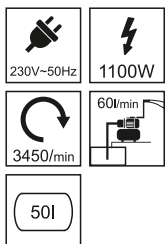

GB Self-priming pump  
DE Selbstansaugende Pumpe  
RU Самовсасывающий насос  
CZ Samonasávací čerpadlo  
SK Samonasávacie čerpadlo  
HU Önfelszívó szivattyú  
RO Pompă de auto-amorsare



Kod EAN  
5901477139499

**Zestaw hydroforowy 50L Js100**      Kod produktu      G81514      1



GB Pressure tank  
DE Drucktank  
RU Напорный бак  
CZ Tlaková nádoba  
SK Tlaková nádoba  
HU Nyomástartály  
RO Rezervor de presiune



Kod EAN  
5901477139666

**Zbiornik hydroforowy przeponowy 24L**      Kod produktu      G81520      1



GB Pressure tank  
DE Drucktank  
RU Напорный бак  
CZ Tlaková nádoba  
SK Tlaková nádoba  
HU Nyomástartály  
RO Rezervor de presiune



Kod EAN  
5901477139673

**Zbiornik hydroforowy przeponowy 50L**      Kod produktu      G81521      1



GB Pressure tank  
DE Drucktank  
RU Напорный бак  
CZ Tlaková nádoba  
SK Tlaková nádoba  
HU Nyomástartály  
RO Rezervor de presiune



Kod EAN  
5901477139680

**Zbiornik hydroforowy przeponowy 100L**      Kod produktu      G81522      1





GB Flexible Hose for Water Pump  
DE Flexibler Schlauch für Wasserpumpe  
RU Гибкий шланг для водяного насоса  
CZ Flexibilní hadice pro vodní čerpadlo  
SK Flexibilná hadica pre vodné čerpadlo  
HU Rugalmas tömlő vízszivattyúhoz  
RO Furtun flexibil pentru pompa de apa



5901477139697

**Wąż antywiibracyjny 50cm z kolanem hydroforu** G81523 1



GB Flexible Hose for Water Pump  
DE Flexibler Schlauch für Wasserpumpe  
RU Гибкий шланг для водяного насоса  
CZ Flexibilní hadice pro vodní čerpadlo  
SK Flexibilná hadica pre vodné čerpadlo  
HU Rugalmas tömlő vízszivattyúhoz  
RO Furtun flexibil pentru pompa de apa



5901477139703

**Wąż antywiibracyjny 60cm z kolanem hydroforu** G81524 1



GB Flexible Hose for Water Pump  
DE Flexibler Schlauch für Wasserpumpe  
RU Гибкий шланг для водяного насоса  
CZ Flexibilní hadice pro vodní čerpadlo  
SK Flexibilná hadica pre vodné čerpadlo  
HU Rugalmas tömlő vízszivattyúhoz  
RO Furtun flexibil pentru pompa de apa



5901477139710

**Wąż antywiibracyjny 70cm z kolanem hydroforu** G81525 1



GB Flexible Hose for Water Pump  
DE Flexibler Schlauch für Wasserpumpe  
RU Гибкий шланг для водяного насоса  
CZ Flexibilní hadice pro vodní čerpadlo  
SK Flexibilná hadica pre vodné čerpadlo  
HU Rugalmas tömlő vízszivattyúhoz  
RO Furtun flexibil pentru pompa de apa



5901477139727

**Wąż antywiibracyjny 80cm z kolanem hydroforu** G81526 1



GB Valve  
DE Ventil  
RU Кран  
CZ Ventil  
SK Ventil  
HU Szelep  
RO Supapă



5901477139734

**Wyjście tłoczne 5-drożne (zawór) hydroforu** G81527 100



GB Manometer  
DE Manometer  
RU Манометр для прессы  
CZ Manometr do lisu  
SK Manometer do lisu  
HU Manométer  
RO Manometru



5901477139758

**Manometr hydroforu 0-12 bar** G81529 200



GB Pressure switch  
DE Druckschalter  
RU Дифференциальный манометр  
CZ Tlakový spínač  
SK Tlakový spínač  
HU Nyomáskapcsoló  
RO Presostat



5901477139741

**Wyłącznik ciśnieniowy hydroforowy 1/4"** G81528 50



max 3800 l/h max 46 m



GB Jet pump  
DE Gartenpumpe  
RU Насос садовый  
CZ Zahradní čerpadlo  
SK Záhradné čerpadlo  
HU Kerti szivattyúhoz  
RO Pompa apa



5901477125522

**Pompa ogrodowa do wody 1200W** G81435 2



30L 16kPa

Dry and wet Filter system







GB Pond cleaner  
DE Teichreiniger  
RU Очиститель пруда  
CZ Čistič rybníků  
SK Čistič na jazierka  
HU Tóporoszívók, iszapszívók  
RO Aspirator umed/uscac



5901477155000

**Odkurczacz do oczka wodnego i basenów** G81089 1







 230V~50Hz	 55W
 2.2m	 3m
 2100l/h	



GB Garden pump  
DE Gartenpumpe  
RU Садовый насос  
CZ Zahradní čerpadlo  
SK Záhradné čerpadlo  
HU Kerti szivattyú  
RO Pompă de grădină



 **Pompka do oczka wodnego + 4 dysze**      Kod produktu **G81470**       **8**





 230V~50Hz	 2W
 0.7m	 170l/h



GB Garden pump  
DE Gartenpumpe  
RU Садовый насос  
CZ Zahradní čerpadlo  
SK Záhradné čerpadlo  
HU Kerti szivattyú  
RO Pompă de grădină



 **Pompka solarna do oczka wodnego 2W**      Kod produktu **G81471**       **10**

 230V~50Hz	 5W
 0.22m	 350l/h



GB Garden pump  
DE Gartenpumpe  
RU Садовый насос  
CZ Zahradní čerpadlo  
SK Záhradné čerpadlo  
HU Kerti szivattyú  
RO Pompă de grădină



 **Pompa solarna do oczka wodnego 5W**      Kod produktu **G81472**       **16**

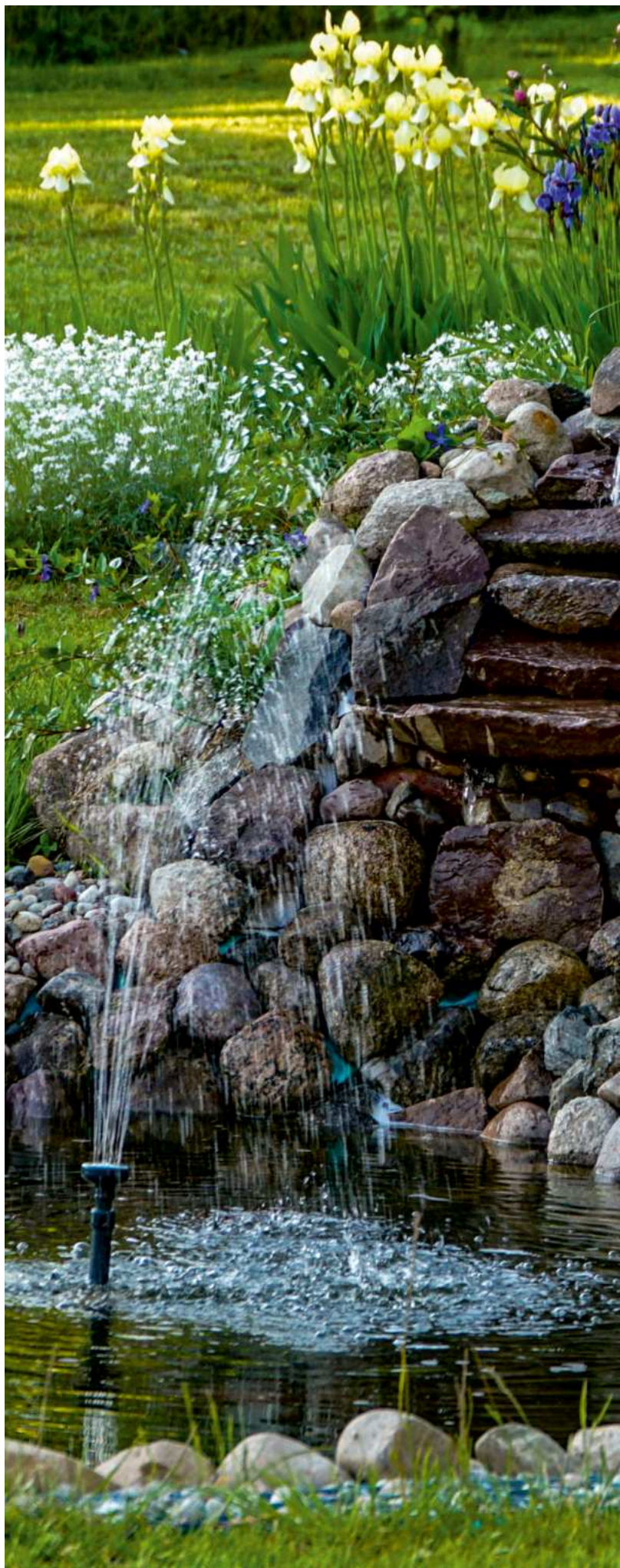



# Wężę i akcesoria ogrodowe / Garden Hoses and accessories



1/2"	30m
1/2"	50m



1/2"	10m
3/4"	



GB Drip hose  
 DE Tropfschlauch  
 RU Капельный шланг  
 CZ Kapačí hadice  
 SK Kvapková hadica  
 HU Locsolótömlő  
 RO Picurare furtun

Kod EAN  
  
 5901477161377  
 Kod EAN  
  
 5901477161384

	Kod produktu	
Wąż nawadniający kroplujący 1/2" 30m	G70071	6
Wąż nawadniający kroplujący 1/2" 50m	G70072	2



GB Soaker hose  
 DE Einweichen Schlauch  
 RU Спринклерный шланг  
 CZ Nádicový zavlažovač  
 SK Nádicový zavlažovač  
 HU Esőztetőtömlő  
 RO Furtun de aspersoare

Kod EAN  
  
 5901477163128

	Kod produktu	
Mgielka ogrodowa - wąż + zraszacze do nawadniania 10m	G70075	50



1"	20m
1"	30m











Kod EAN  
5901477170430  
Kod EAN  
5901477170447

GB Garden hose  
DE Gartenschlauch  
RU Садовый шланг  
CZ Zahradní hadice  
SK Záhradné hadice  
HU Kerti tömlő  
RO Furtun de gradina

GEKO		Kod produktu	
Wąż ogrodowy 4 Warstwowy 1" 20m GEKO NEW	G73781	55	
Wąż ogrodowy 4 Warstwowy 1" 30m GEKO NEW	G73789	45	

1/2"	20m
1/2"	30m
1/2"	50m











Kod EAN  
5901477162091  
Kod EAN  
5901477162107  
Kod EAN  
5901477162114

GB Garden hose  
DE Gartenschlauch  
RU Садовый шланг  
CZ Zahradní hadice  
SK Záhradné hadice  
HU Kerti tömlő  
RO Furtun de gradina

GEKO		Kod produktu	
Wąż ogrodowy 4 Warstwowy 1/2" 20m GEKO NEW	G73782	198	
Wąż ogrodowy 4 Warstwowy 1/2" 30m GEKO NEW	G73783	154	
Wąż ogrodowy 4 Warstwowy 1/2" 50m GEKO NEW	G73785	108	

3/4"	20m
3/4"	30m
3/4"	50m





















Kod EAN  
5901477162121  
Kod EAN  
5901477162138  
Kod EAN  
5901477162145

GB Garden hose  
DE Gartenschlauch  
RU Садовый шланг  
CZ Zahradní hadice  
SK Záhradné hadice  
HU Kerti tömlő  
RO Furtun de gradina

GEKO		Kod produktu	
Wąż ogrodowy 4 Warstwowy 3/4" 20m GEKO NEW	G73786	117	
Wąż ogrodowy 4 Warstwowy 3/4" 30m GEKO NEW	G73787	88	
Wąż ogrodowy 4 Warstwowy 3/4" 50m GEKO NEW	G73788	45	

1/2"	20m
1/2"	30m
1/2"	50m















Kod EAN  
5901477156984  
Kod EAN  
5901477156991  
Kod EAN  
5901477157004



GB Garden hose  
DE Gartenschlauch  
RU Садовый шланг  
CZ Zahradní hadice  
SK Záhradné hadice  
HU Kerti tömlő  
RO Furtun de gradina

GEKO		Kod produktu	
Wąż ogrodowy wzmacniany BLACK&RED 1/2" 20m	G73692	132	
Wąż ogrodowy wzmacniany BLACK&RED 1/2" 30m	G73693	110	
Wąż ogrodowy wzmacniany BLACK&RED 1/2" 50m	G73694	81	

3/4"	20m
3/4"	30m
3/4"	50m













Kod EAN  
5901477157011  
Kod EAN  
5901477157028  
Kod EAN  
5901477157035

GB Garden hose  
DE Gartenschlauch  
RU Садовый шланг  
CZ Zahradní hadice  
SK Záhradné hadice  
HU Kerti tömlő  
RO Furtun de gradina

GEKO		Kod produktu	
Wąż ogrodowy wzmacniany BLACK&RED 3/4" 20m	G73695	117	
Wąż ogrodowy wzmacniany BLACK&RED 3/4" 30m	G73696	88	
Wąż ogrodowy wzmacniany BLACK&RED 3/4" 50m	G73697	45	

1"	20m
1"	30m



Kod EAN  
5901477157042  
Kod EAN  
5901477157059

GB Garden hose  
DE Gartenschlauch  
RU Садовый шланг  
CZ Zahradní hadice  
SK Záhradné hadice  
HU Kerti tömlő  
RO Furtun de gradina

GEKO		Kod produktu	
Wąż ogrodowy wzmacniany BLACK&RED 1" 20m	G73698	55	
Wąż ogrodowy wzmacniany BLACK&RED 1" 30m	G73699	45	



**3/4"**



GB Fittings for garden hose  
DE Armaturen für Gartenschlauch  
RU Арматура для поливочных шлангов  
CZ Adaptér na kohoutek  
SK Adaptér na kohútik  
HU Locsolótömlő csatlakozó  
RO Conectori furtun gradina

Kod EAN  
5901477118074

Kod produktu  
**Przyłącze na kran 3/4" BLUE LINE** G73020 1000

**1"**



GB Fittings for garden hose  
DE Armaturen für Gartenschlauch  
RU Арматура для поливочных шлангов  
CZ Adaptér na kohoutek  
SK Adaptér na kohútik  
HU Locsolótömlő csatlakozó  
RO Conectori furtun gradina

Kod EAN  
5901477124297

Kod produktu  
**Przyłącze na kran 1" z red.3/4** G73021 500

**3/4"**



GB Fittings for garden hose  
DE Armaturen für Gartenschlauch  
RU Арматура для поливочных шлангов  
CZ Adaptér na kohoutek  
SK Adaptér na kohútik  
HU Locsolótömlő csatlakozó  
RO Conectori furtun gradina

Kod EAN  
5901477118081

Kod produktu  
**Przyłącze na kran 3/4 z red.1/2 BLUE LINE** G73022 1000

**1"**



GB Fittings for garden hose  
DE Armaturen für Gartenschlauch  
RU Арматура для поливочных шлангов  
CZ Adaptér na kohoutek  
SK Adaptér na kohútik  
HU Locsolótömlő csatlakozó  
RO Conectori furtun gradina

Kod EAN  
5901477124280

Kod produktu  
**Przyłącze na kran 1" BLUE LINE** G73023 1000

**3/4"**



GB Fittings for garden hose  
DE Armaturen für Gartenschlauch  
RU Арматура для поливочных шлангов  
CZ Adaptér na kohoutek  
SK Adaptér na kohútik  
HU Locsolótömlő csatlakozó  
RO Conectori furtun gradina

Kod EAN  
5901477118067

Kod produktu  
**Wkrętka do urz.zrasz.3/4gwint BLUE LINE** G73025 1000

**3/4"**



GB Fittings for garden hose  
DE Armaturen für Gartenschlauch  
RU Арматура для поливочных шлангов  
CZ Adaptér na kohoutek  
SK Adaptér na kohútik  
HU Locsolótömlő csatlakozó  
RO Conectori furtun gradina

Kod EAN  
5901477124303

Kod produktu  
**Nypel do szybkozłączek** G73026 1000

**3/4"**



GB Fittings for garden hose  
DE Armaturen für Gartenschlauch  
RU Арматура для поливочных шлангов  
CZ Adaptér na kohoutek  
SK Adaptér na kohútik  
HU Locsolótömlő csatlakozó  
RO Conectori furtun gradina

Kod EAN  
5901477124310

Kod produktu  
**Trójnik na szybkozłączki** G73027 500

**1/2"**



GB Fittings for garden hose  
DE Armaturen für Gartenschlauch  
RU Арматура для поливочных шлангов  
CZ Adaptér na kohoutek  
SK Adaptér na kohútik  
HU Locsolótömlő csatlakozó  
RO Conectori furtun gradina

Kod EAN  
5901477118111

Kod produktu  
**Szybkozłączka 1/2" BLUE LINE** G73030 500

**1/2"**



GB Fittings for garden hose  
DE Armaturen für Gartenschlauch  
RU Арматура для поливочных шлангов  
CZ Adaptér na kohoutek  
SK Adaptér na kohútik  
HU Locsolótömlő csatlakozó  
RO Conectori furtun gradina

Kod EAN  
5901477118104

Kod produktu  
**Szybkozłączka 1/2"/blister BLUE LINE** G73030B 200

**1/2" STOP**



GB Fittings for garden hose  
DE Armaturen für Gartenschlauch  
RU Арматура для поливочных шлангов  
CZ Adaptér na kohoutek  
SK Adaptér na kohútik  
HU Locsolótömlő csatlakozó  
RO Conectori furtun gradina

Kod EAN  
5901477118135

Kod produktu  
**Szybkozłączka 1/2" ze stopem** G73031 500

**1/2" STOP**



GB Fittings for garden hose  
DE Armaturen für Gartenschlauch  
RU Арматура для поливочных шлангов  
CZ Adaptér na kohoutek  
SK Adaptér na kohútik  
HU Locsolótömlő csatlakozó  
RO Conectori furtun gradina

Kod EAN  
5901477118128

Kod produktu  
**Szybkozłączka 1/2" ze stopem/blister BLUE LINE** G73031B 200

**3/4"**



GB Fittings for garden hose  
DE Armaturen für Gartenschlauch  
RU Арматура для поливочных шлангов  
CZ Adaptér na kohoutek  
SK Adaptér na kohútik  
HU Locsolótömlő csatlakozó  
RO Conectori furtun gradina

Kod EAN  
5901477118159

Kod produktu  
**Szybkozłączka 3/4 BLUE LINE** G73032 400

**3/4"**



GB Fittings for garden hose  
DE Armaturen für Gartenschlauch  
RU Арматура для поливочных шлангов  
CZ Adaptér na kohoutek  
SK Adaptér na kohútik  
HU Locsolótömlő csatlakozó  
RO Conectori furtun gradina

Kod EAN  
5901477118142

Kod produktu   
**Szybkozłączka 3/4"/blister BLUE LINE G73032B 240**

**3/4" STOP**



GB Fittings for garden hose  
DE Armaturen für Gartenschlauch  
RU Арматура для поливочных шлангов  
CZ Adaptér na kohoutek  
SK Adaptér na kohútik  
HU Locsolótömlő csatlakozó  
RO Conectori furtun gradina

Kod EAN  
5901477118166

Kod produktu   
**Szybkozłączka 3/4 ze stopem BLUE LINE G73033 500**

**3/4" STOP**



GB Fittings for garden hose  
DE Armaturen für Gartenschlauch  
RU Арматура для поливочных шлангов  
CZ Adaptér na kohoutek  
SK Adaptér na kohútik  
HU Locsolótömlő csatlakozó  
RO Conectori furtun gradina

Kod EAN  
5901477118173

Kod produktu   
**Szybkozłączka 3/4" ze stopem blister BLUE LINE G73033B 240**

**1/2"**



GB Fittings for garden hose  
DE Armaturen für Gartenschlauch  
RU Арматура для поливочных шлангов  
CZ Adaptér na kohoutek  
SK Adaptér na kohútik  
HU Locsolótömlő csatlakozó  
RO Conectori furtun gradina

Kod EAN  
5901477118180

Kod produktu   
**Reparator do węża 1/2 BLUE LINE G73035 500**

**3/4"**



GB Fittings for garden hose  
DE Armaturen für Gartenschlauch  
RU Арматура для поливочных шлангов  
CZ Adaptér na kohoutek  
SK Adaptér na kohútik  
HU Locsolótömlő csatlakozó  
RO Conectori furtun gradina

Kod EAN  
5901477118210

Kod produktu   
**Reparator do węża 3/4 BLUE LINE G73036 500**

**1/2"**



GB Fittings for garden hose  
DE Armaturen für Gartenschlauch  
RU Арматура для поливочных шлангов  
CZ Adaptér na kohoutek  
SK Adaptér na kohútik  
HU Locsolótömlő csatlakozó  
RO Conectori furtun gradina

Kod EAN  
5901477118197

Kod produktu   
**Reparator do węża 1/2"/blister BLUE LINE G73037 240**

**3/4"**



GB Fittings for garden hose  
DE Armaturen für Gartenschlauch  
RU Арматура для поливочных шлангов  
CZ Adaptér na kohoutek  
SK Adaptér na kohútik  
HU Locsolótömlő csatlakozó  
RO Conectori furtun gradina

Kod EAN  
5901477129971

Kod produktu   
**Reparator do węża 3/4"/blister BLUE LINE G73038 240**

**1/2"  
3/4"**



GB Fittings for garden hose  
DE Armaturen für Gartenschlauch  
RU Арматура для поливочных шлангов  
CZ Adaptér na kohoutek  
SK Adaptér na kohútik  
HU Locsolótömlő csatlakozó  
RO Conectori furtun gradina

Kod EAN  
5901477175718

Kod produktu   
**Reparator do węża 1/2"-3/4" BLUE LINE G73039 500**



GB Fittings for garden hose  
DE Armaturen für Gartenschlauch  
RU Арматура для поливочных шлангов  
CZ Adaptér na kohoutek  
SK Adaptér na kohútik  
HU Locsolótömlő csatlakozó  
RO Conectori furtun gradina

Kod EAN  
5901477118029

Kod produktu   
**Dysza zraszająca z regulacją/blister BLUE LINE G73040 200**



GB Fittings for garden hose  
DE Armaturen für Gartenschlauch  
RU Арматура для поливочных шлангов  
CZ Adaptér na kohoutek  
SK Adaptér na kohútik  
HU Locsolótömlő csatlakozó  
RO Conectori furtun gradina

Kod EAN  
5901477118036

Kod produktu   
**Dysza zraszająca z regulacją BLUE LINE G73041 400**

**1/2"**





GB Hose nozzle, tap adaptor  
DE Bewässerungs Spritz und Anschlussset  
RU Набор поливочный  
CZ Sprcha záhradní  
SK Sprcha záhradné  
HU Kerti locsoló  
RO Stropitor

Kod EAN  
5901477175725

Kod produktu   
**Komplet 4-elem. 1/2" do zraszania TPR LINE G73042 80**

**3/4"**

GB Hose nozzle, tap adaptor  
DE Bewässerungs Spritz und Anschlussset  
RU Набор поливочный  
CZ Sprcha záhradní  
SK Sprcha záhradné  
HU Kerti locsoló  
RO Stropitor

Kod EAN  
5901477175732

Kod produktu   
**Kpl.4-elem. 3/4" do zraszania TPR LINE G73043 80**



1/2"



GB Hose nozzle, tap adaptor  
DE Bewässerungs Spritz und Anschlussset  
RU Набор поливочный  
CZ Sprcha zahradní  
SK Sprcha záhradné  
HU Kerti locsoló  
RO Stropitor



Kod produktu **G73047** 80  
Kpl.4-elem. 1/2" do zraszania/blister BLUE LINE

3/4"



GB Hose nozzle, tap adaptor  
DE Bewässerungs Spritz und Anschlussset  
RU Набор поливочный  
CZ Sprcha zahradní  
SK Sprcha záhradné  
HU Kerti locsoló  
RO Stropitor



Kod produktu **G73048** 80  
Kpl.4-elem. 3/4" do zraszania/blister BLUE LINE



GB Sprinkling gun  
DE Spritzpistole  
RU Оросительный пистолет  
CZ Postřikovací pistole  
SK Postrekovacie pištole  
HU Öntöző pisztoly  
RO Pistol pt. pulverizare



Kod produktu **G73000** 48  
Pistolet metal. z regulacją PROFI



GB Sprinkling gun  
DE Spritzpistole  
RU Оросительный пистолет  
CZ Postřikovací pistole  
SK Postrekovacie pištole  
HU Öntöző pisztoly  
RO Pistol pt. pulverizare



Kod produktu **G73008** 48  
Pistolet plastik.7-funk.BLUE LINE GEKO



GB Sprinkling gun  
DE Spritzpistole  
RU Оросительный пистолет  
CZ Postřikovací pistole  
SK Postrekovacie pištole  
HU Öntöző pisztoly  
RO Pistol pt. pulverizare



Kod produktu **G73009** 48  
Pistolet 8-funk. srebrny,r.guma



GB Sprinkling gun  
DE Spritzpistole  
RU Оросительный пистолет  
CZ Postřikovací pistole  
SK Postrekovacie pištole  
HU Öntöző pisztoly  
RO Pistol pt. pulverizare



Kod produktu **G73012** 36  
Pistolet ogrodowy mosiężny 2-funkc. regulowany

do 24 m



GB Garden sprayer  
DE Garten sprinkler  
RU Распылитель  
CZ Sprcha zahradní  
SK Sprcha záhradné  
HU Kerti locsoló  
RO Stropitor



Kod produktu **G73050** 50  
Zraszacz pulsacyjny plastik BLUE LINE

do 24 m



GB Garden sprayer  
DE Garten sprinkler  
RU Распылитель  
CZ Sprcha zahradní  
SK Sprcha záhradné  
HU Kerti locsoló  
RO Stropitor



Kod produktu **G73051** 40  
Zraszacz pulsacyjny metalowy

do 24 m



GB Garden sprayer  
DE Garten sprinkler  
RU Распылитель  
CZ Sprcha zahradní  
SK Sprcha záhradné  
HU Kerti locsoló  
RO Stropitor



Kod produktu **G73056** 10  
Zraszacz metalowy pulsacyjny na stojaku

do 250 m<sup>2</sup>



GB Garden sprayer  
DE Garten sprinkler  
RU Распылитель  
CZ Sprcha zahradní  
SK Sprcha záhradné  
HU Kerti locsoló  
RO Stropitor



Kod produktu **G73060** 6  
Zraszacz wahadlowy typ 1 April

do  
250  
m<sup>2</sup>



GB Garden sprayer  
DE Garten sprinkler  
RU Распылитель  
CZ Sprcha zahradní  
SK Sprcha záhradné  
HU Kerti locsoló  
RO Stropitor



Kod EAN  
5901477157981

**Zraszacz wahadłowy typ 2 May**      Kod produktu **G73061**      6

do  
250  
m<sup>2</sup>



GB Garden sprayer  
DE Garten sprinkler  
RU Распылитель  
CZ Sprcha zahradní  
SK Sprcha záhradné  
HU Kerti locsoló  
RO Stropitor



Kod EAN  
5901477157998

**Zraszacz wahadłowy typ 3 June**      Kod produktu **G73062**      6

1/2"    45m



GB Hose holder  
DE Gartenschlauchträger  
RU Барабан для намотки поливочного шланга  
CZ Stojan navjceč na zahradní hadici  
SK Stojan navjceč na zahradní hadicu  
HU Utartódob locsolótömlöhöz  
RO Suport pt. furtun



Kod EAN  
5901477118289

**Wózek do 45m węża ogrodowego/zielony/**      Kod produktu **G73220**      6

1/2"    25m



GB Hose holder  
DE Gartenschlauchträger  
RU Барабан для намотки поливочного шланга  
CZ Stojan navjceč na zahradní hadici  
SK Stojan navjceč na zahradní hadicu  
HU Utartódob locsolótömlöhöz  
RO Suport pt. furtun



Kod EAN  
5901477118296

**Stojak do 25m węża ogrodowego/niebieski/**      Kod produktu **G73222**      8

1/2"    60m



GB Hose holder  
DE Gartenschlauchträger  
RU Барабан для намотки поливочного шланга  
CZ Stojan navjceč na zahradní hadici  
SK Stojan navjceč na zahradní hadicu  
HU Utartódob locsolótömlöhöz  
RO Suport pt. furtun



Kod EAN  
5901477118302

**Wózek do 60m węża ogrodowego/niebieski/**      Kod produktu **G73224**      4

1/2"    60m



GB Hose holder  
DE Gartenschlauchträger  
RU Барабан для намотки поливочного шланга  
CZ Stojan navjceč na zahradní hadici  
SK Stojan navjceč na zahradní hadicu  
HU Utartódob locsolótömlöhöz  
RO Suport pt. furtun



Kod EAN  
5901477159664

**Wózek na wąż 60m ALU-POLSKA**      Kod produktu **G73227**      5





GB Hose hanger  
DE Gartenschlauchträger  
RU Кронштейн настенный для шланга  
CZ Věšák na hadici zahradní  
SK Vešiak na hadicu záhradné  
HU Kerttömmlő-akasztó  
RO Suport de perete pt. furtun

Kod EAN  
5901477140143

Kod produktu  
**Zwijacz-wieszak węży ogrodowego** G73225 50



GB Brush for wheel and rim wash  
DE Bürste für rad- und felgenreinigung  
RU Щетка для чистки колес и дисков  
CZ Kartáč pro čištění kol a ráfků  
SK Kefa pre čistenie kolies a ráfikov  
HU Kefe a kerekekhez és a keréktárcsához  
RO Perie pentru curatat jante

Kod EAN  
5901477151187

Kod produktu  
**Szczotka do mycia kół i opon** G73800 12



GB Car wash brush  
DE Autowaschbürste  
RU Щетка для мытья автомобиля  
CZ Průtokový mycí kartáč na mytí vozu  
SK Prítokový umývacia kefa na umývanie vozidla  
HU Autómosó kefe  
RO Perie pentru jante si elemente de caroserie

Kod EAN  
5901477151194

Kod produktu  
**Szczotka do mycia auta, kół i opon z podłączeniem do węży** G73801 50

0.7-1.3 m



GB Car wash brush  
DE Autowaschbürste  
RU Щетка для мытья автомобиля  
CZ Průtokový mycí kartáč na mytí vozu  
SK Prítokový umývacia kefa na umývanie vozidla  
HU Autómosó kefe  
RO Perie pentru jante si elemente de caroserie

Kod EAN  
5901477151200

Kod produktu  
**Teleskopowa szczotka do mycia auta 0.7-1.3 m** G73802 12

1.3-2.2 m



GB Car wash brush  
DE Autowaschbürste  
RU Щетка для мытья автомобиля  
CZ Průtokový mycí kartáč na mytí vozu  
SK Prítokový umývacia kefa na umývanie vozidla  
HU Autómosó kefe  
RO Perie pentru jante si elemente de caroserie

Kod EAN  
5901477151217

Kod produktu  
**Teleskopowa szczotka do mycia auta czteropłaszczyznowa 1.3-2.2** G73803 8

31x14x12 cm





GB Car wash brush  
DE Autowaschbürste  
RU Щетка для мытья автомобиля  
CZ Průtokový mycí kartáč na mytí vozu  
SK Prítokový umývacia kefa na umývanie vozidla  
HU Autómosó kefe  
RO Perie pentru jante si elemente de caroserie

Kod EAN  
5901477177378

Kod produktu  
**Szczotka do mycia samochodu 4 płaszczyznowa 31x14x12cm** G73804 10

22x12x7 cm

GB Car Wash Sponge  
DE Autowaschschwamm  
RU Губка для автомойки  
CZ Houbiček automobilů  
SK Hubiek automobilov  
HU Autószivacs  
RO Burete pentru spalare auto

Kod EAN  
5901477151224

Kod produktu  
**Gąbka do mycia auta** G73810 50

24x11x5.5 cm



GB Microfiber Car Wash Sponge  
DE Microfaser-Autowaschschwamm  
RU Губка для мытья автомобилей из микрофибры  
CZ Houbiček automobilů z mikrovláken  
SK Hubiek automobilov mikrovlnáčen  
HU Szivacs autómosó mikroszálás  
RO Burete pentru spalare auto cu microfibra

Kod EAN  
5901477151231

Kod produktu  
**Gąbka z mikrofibry do mycia auta** G73811 50

24x12x6 cm



GB Car wash sponge  
DE Autowaschschwamm  
RU Губка для автомойки  
CZ Houbiček automobilů  
SK Hubiek automobilov  
HU Autószivacs  
RO Burete pentru spalare auto

Kod EAN  
5901477151248

Kod produktu  
**Szenilowa gąbka do mycia auta** G73812 50



GB Rim brush  
DE Felgenbürste  
RU Ободная щетка  
CZ Kartáč na ráfky  
SK Kefa na ráfiky  
HU Peremkefe  
RO Perie pentru margini

Kod EAN  
5901477168901

Kod produktu  
**Szczotka do mycia felg z długą rączką** G73820 25



GB Rim brush  
DE Felgenbürste  
RU Ободная щетка  
CZ Kartáč na ráfky  
SK Kefa na ráfiky  
HU Peremkefe  
RO Perie pentru margini

Kod EAN  
5901477168895

Kod produktu  
**Szczotka do mycia felg i kołpaków** G73821 50

5pcs



GB Wash brush set  
DE Waschbürstenset  
RU Набор стиральных щеток  
CZ Sada kartáčů mytí  
SK Súprava kefy na umývanie  
HU Mosókefe készlet  
RO Set perie de spălare

Kod EAN  
5901477168918

Kod produktu  
**Zestaw pędzli 5szt. do mycia detailingowego 20-40mm** G73825 50

2-4.9  
m



1.3-3  
m



GB Telescopic brush for cleaning photovoltaic panels  
 DE Teleskopbürste zum Reinigen von Photovoltaikmodulen  
 RU Телескопическая щетка для очистки фотоэлектрических  
 CZ Teleskopický kartáč na čištění fotovoltaických panelů  
 SK Teleskopická kefa na čistenie fotovoltaických panelov  
 HU Teleszkópos kefe fotovoltaikus panelek tisztításához  
 RO Perie telescopica pentru curatarea panourilor fotovoltaice



5901477180545

Szczotka teleskopowa do mycia paneli fotowoltaicznych 2-4.9m G73880 6

GB Telescopic brush for cleaning photovoltaic panels  
 DE Teleskopbürste zum Reinigen von Photovoltaikmodulen  
 RU Телескопическая щетка для очистки фотоэлектрических  
 CZ Teleskopický kartáč na čištění fotovoltaických panelů  
 SK Teleskopická kefa na čistenie fotovoltaických panelov  
 HU Teleszkópos kefe fotovoltaikus panelek tisztításához  
 RO Perie telescopica pentru curatarea panourilor fotovoltaice



5901477180552

Szczotka teleskopowa do mycia paneli fotowoltaicznych 1.3-3m G73881 12

## Wężę strażackie / Fire Hoses



1" 20m



2" 30m



GB Firehose  
 DE Feuerwehr  
 RU Пожарный рукав  
 CZ Požární hadice  
 SK Požiarna hadice  
 HU Locsólőtömlő csatlakozóval  
 RO Furtun de incendiu



5901477112744

Wąż parciany 1"20m z końcówkami G70001 10

GB Firehose  
 DE Feuerwehr  
 RU Пожарный рукав  
 CZ Požární hadice  
 SK Požiarna hadice  
 HU Locsólőtömlő csatlakozóval  
 RO Furtun de incendiu



5901477128813

Wąż parciany/strażak/ 2" 30m ze złączkami G70002 5



2" 20m



GB Firehose  
DE Feuerwehr  
RU Пожарный рукав  
CZ Požární hadice  
SK Požiarna hadice  
HU Locsolótömlő csatlakozóval  
RO Furtun de incendiu



Kod EAN  
5901477112751

**Wąż parciany/strażacki 2" 20m,3,2kg lekki** G70003 5

2" 20m



GB Firehose  
DE Feuerwehr  
RU Пожарный рукав  
CZ Požární hadice  
SK Požiarna hadice  
HU Locsolótömlő csatlakozóval  
RO Furtun de incendiu



Kod EAN  
5901477112768

**Wąż parciany/strażak/2" 20m 8 bar/ciężki-5kg/** G70004 5

3" 20m



GB Firehose  
DE Feuerwehr  
RU Пожарный рукав  
CZ Požární hadice  
SK Požiarna hadice  
HU Locsolótömlő csatlakozóval  
RO Furtun de incendiu



Kod EAN  
5901477126840

**Wąż parciany/strażak/3" 20m 8 bar ze złączkami** G70005 5

1" 20m



2" 20m

3" 20m

2" 30m



GB Firehose  
DE Feuerwehr  
RU Пожарный рукав  
CZ Požární hadice  
SK Požiarna hadice  
HU Locsolótömlő csatlakozóval  
RO Furtun de incendiu



Kod EAN  
5901477128806



Kod EAN  
5901477148897



Kod EAN  
5901477128790



Kod EAN  
5901477169861

**Wąż parciany/strażak/ 1" 20m( bez końcówek)** G70025 2  
**Wąż parciany/strażak/ 2" 20m ( bez końcówek)** G70026 5  
**Wąż parciany/strażak/ 3" 20m ( bez końcówek)** G70027 2  
**Wąż parciany/strażak/ 2" 30m ( bez końcówek)** G70028 2

2" 20m



2" 30m



GB Firehose  
DE Feuerwehr  
RU Пожарный рукав  
CZ Požární hadice  
SK Požiarna hadice  
HU Locsolótömlő csatlakozóval  
RO Furtun de incendiu



Kod EAN  
5901477179983



Kod EAN  
5901477179990

**Wąż parciany czerwony /strażak/ 2" 20m (bez końcówek)** G70033 5  
**Wąż parciany czerwony /strażak/ 2" 30m (bez końcówek)** G70034 5

2" 30m



GB Firehose  
DE Feuerwehr  
RU Пожарный рукав  
CZ Požární hadice  
SK Požiarna hadice  
HU Locsolótömlő csatlakozóval  
RO Furtun de incendiu



Kod EAN  
5901477179976

**Wąż parciany czerwony /strażak/ 2" 30m ze złączkami** G70035 5

1"	20m
1"	30m
1"	50m
1"	100m



Kod EAN  
5901477112775  
Kod EAN  
5901477131585  
Kod EAN  
5901477112782  
Kod EAN  
5901477112799

GB Firehose  
DE Feuerwehr  
RU Пожарный рукав  
CZ Požární hadice  
SK Požiarna hadice  
HU Locsolótömlő csatlakozóval  
RO Furtun de incendiu

Kod produktu	Waż	Waż PCV 1" - 20m(niebieski-smell) 2 BARY	G70006	10
		Waż PCV 1" - 30m(niebieski-smell) 2 BARY	G70013	10
		Waż PCV 1" - 50m (niebieski-smell) 2 BARY	G70007	1
		Waż PCV 1" - 100m(niebieski-smell) 2 BARY	G70008	1

2"	20m
2"	30m
2"	50m
2"	100m



Kod EAN  
5901477112836  
Kod EAN  
5901477129032  
Kod EAN  
5901477112829  
Kod EAN  
5901477112805

GB Firehose  
DE Feuerwehr  
RU Пожарный рукав  
CZ Požární hadice  
SK Požiarna hadice  
HU Locsolótömlő csatlakozóval  
RO Furtun de incendiu

Kod produktu	Waż	Waż PCV 2" - 20m (niebieski-smell) 2 BARY	G70016	5
		Waż PCV 2" - 30m (niebieski-smell) 2 BARY	G70014	5
		Waż PCV 2" - 50m (niebieski-smell) 2 BARY	G70015	1
		Waż PCV 2" - 100m(niebieski-smell) 2 BARY	G70010	1

2"	20m
2"	50m
2"	100m



Kod EAN  
5901477136368  
Kod EAN  
5901477136375  
Kod EAN  
5901477136382

GB Firehose  
DE Feuerwehr  
RU Пожарный рукав  
CZ Požární hadice  
SK Požiarna hadice  
HU Locsolótömlő csatlakozóval  
RO Furtun de incendiu

Kod produktu	Waż	Waż PCV 2" 20m zielony 2 BARY(bezzapachowy)	G70020	5
		Waż PCV 2" 50m zielony 2 BARY(bezzapachowy) <td>G70021</td> <td>1</td>	G70021	1
		#Waż PCV 2" 100m zielony 2 BARY(bezzapachowy) <td>G70022</td> <td>1</td>	G70022	1

1"	25mm
2"	50mm



Kod EAN  
5901477161735  
Kod EAN  
5901477161742

GB Suction hose  
DE Saugschlauch  
RU Всасывающий шланг  
CZ Sací hadice  
SK Sacia hadica  
HU Szívótömlő  
RO Furtun de aspiratie

Kod produktu	Waż	Waż ssawny 1 cal 1" 25mm - wzmacniany drutem 5m	G70040	1
		Waż ssawny 2 cal 2" 50mm - wzmacniany drutem 5m <td>G70041</td> <td>1</td>	G70041	1

2"	20m
----	-----



Kod EAN  
5901477129803

GB Firehose  
DE Feuerwehr  
RU Пожарный рукав  
CZ Požární hadice  
SK Požiarna hadice  
HU Locsolótömlő csatlakozóval  
RO Furtun de incendiu

Kod produktu	Waż	Waż parciany 2" 20m ze złączkami KELTIN	K00150	2
--------------	-----	---	--------	---

2"	30m
----	-----



Kod EAN  
5901477129810

GB Firehose  
DE Feuerwehr  
RU Пожарный рукав  
CZ Požární hadice  
SK Požiarna hadice  
HU Locsolótömlő csatlakozóval  
RO Furtun de incendiu

Kod produktu	Waż	Waż parciany 2" 30m ze złączkami KELTIN	K00151	5
--------------	-----	---	--------	---



1"-2"



GB Adapter  
DE Reduktion  
RU Переходник  
CZ Adaptér pro požární hadici  
SK Adaptér pre požiarne hadicu  
HU Csonkkapocs adapter  
RO Adaptor pentru furtun de incendiu



5901477112843

**Redukcja do węzła parcianego 1"-2"** Kod produktu **G70100** 100

2"-3"



GB Adapter  
DE Reduktion  
RU Переходник  
CZ Adaptér pro požární hadici  
SK Adaptér pre požiarne hadicu  
HU Csonkkapocs adapter  
RO Adaptor pentru furtun de incendiu



5901477112850

**Redukcja do węzła 2"-3"** Kod produktu **G70101** 45

2"



GB Adaptor for fire hose  
DE Druchverbinderarmatur  
RU Наконечник для шланга  
CZ Adaptér pro požární hadici  
SK Adaptér pre požiarne hadicu  
HU Tömítőoldó csomkapocs  
RO Adaptor pentru furtun de incendiu



5901477112867

**Złączka węzła 2"** Kod produktu **G70102** 50

2"



GB Adaptor for fire hose  
DE Druchverbinderarmatur  
RU Наконечник для шланга  
CZ Adaptér pro požární hadici  
SK Adaptér pre požiarne hadicu  
HU Tömítőoldó csomkapocs  
RO Adaptor pentru furtun de incendiu



5901477173851

**Złączka strażacka do pompy/węzła 2" – gwint wewnętrzny** Kod produktu **G70104** 150

2"



GB Adaptor for fire hose  
DE Druchverbinderarmatur  
RU Наконечник для шланга  
CZ Adaptér pro požární hadici  
SK Adaptér pre požiarne hadicu  
HU Tömítőoldó csomkapocs  
RO Adaptor pentru furtun de incendiu



5901477122309

**Złączka strażacka do pompy/węzła 2"** Kod produktu **G70105** 100



2"



GB Water cannon with bearing  
DE Wasserkanone mit Lager  
RU Водяная пушка с подшипником  
CZ Vodní dělo s ložiskem  
SK Vodné dělo s ložiskom  
HU Vízágyú csapágyazással  
RO Tun de apă cu rulment



5901477171499

**Prądownica strażacka – działko do wody 2"** Kod produktu **G70106** 20

1"



GB Water cannon with bearing  
DE Wasserkanone mit Lager  
RU Водяная пушка с подшипником  
CZ Vodní dělo s ložiskem  
SK Vodné dělo s ložiskom  
HU Vízágyú csapágyazással  
RO Tun de apă cu rulment



5901477173509

**Prądownica strażacka – działko do wody 1"** Kod produktu **G70107** 50

2"



GB Fire nozzle  
DE Feuerlöschschlauchdüse  
RU Пожарное сопло  
CZ Požární tryska  
SK Požiarna dýza  
HU Tűzoltó fúvóka  
RO Teava refulare



5901477173875

**Prądownica strażacka do wody 2"** Kod produktu **G70108** 25

1"



GB Fire nozzle  
DE Feuerlöschschlauchdüse  
RU Пожарное сопло  
CZ Požární tryska  
SK Požiarna dýza  
HU Tűzoltó fúvóka  
RO Teava refulare



5901477173882

**Prądownica strażacka do wody 1"** Kod produktu **G70109** 100

# Plandeki / Tarpaulins



100g



Kod EAN  
  
 5901477168963  
 Kod EAN  
  
 5901477168970  
 Kod EAN  
  
 5901477168987

GB Tarpaulin  
 DE Plane  
 RU Тент  
 CZ Plachta  
 SK Plachta  
 HU Ponyva  
 RO Husă

EKO	Kod produktu	
Plandeka "kamuflač-moro" 1,83x3m 100gsm	G70610	30
Plandeka "kamuflač-moro" 3,66x3m 100gsm	G70611	15
Plandeka "kamuflač-moro" 3,66x4m 100gsm	G70612	12

100g



Kod EAN  
  
 5901477168994  
 Kod EAN  
  
 5901477169007  
 Kod EAN  
  
 5901477169014  
 Kod EAN  
  
 5901477169021

GB Tarpaulin  
 DE Plane  
 RU Тент  
 CZ Plachta  
 SK Plachta  
 HU Ponyva  
 RO Husă

EKO	Kod produktu	
Plandeka "kamuflač-moro" 5,49x4m 100gsm	G70613	8
Plandeka "kamuflač-moro" 5,49x6m 100gsm	G70614	5
Plandeka "kamuflač-moro" 5,49x8m 100gsm	G70615	4
Plandeka "kamuflač-moro" 5,49x10m 100gsm	G70616	3



wodoodporna  
 łatwo zmywalna  
 pleśńoodporna  
 łatwa w użyciu  
 wyposażona w aluminiowe otwory do mocowania co 1 m  
 tolerancja wymiaru +/- 5%



Kod EAN  
 5901477124914  
 Kod EAN  
 5901477124921  
 Kod EAN  
 5901477113246  
 Kod EAN  
 5901477113253  
 Kod EAN  
 5901477113260  
 Kod EAN  
 5901477113277  
 Kod EAN  
 5901477113284  
 Kod EAN  
 5901477113291  
 Kod EAN  
 5903240385065  
 Kod EAN  
 5901477113314  
 Kod EAN  
 5901477113321

GB Tarpaulin  
 DE Plane  
 RU Тент  
 CZ Plachta  
 SK Plachta  
 HU Ponyva  
 RO Husă

Kod produktu		
G01927	30	Plandeka 2x4m lekka/niebieska +/-5%
G01928	30	Plandeka 3x3m lekka/niebieska +/-5%
G01930	40	Plandeka 2x3m lekka/niebieska +/-5%
G01931	20	Plandeka 3x4m lekka/niebieska +/-5%
G01932	16	Plandeka 3x5m lekka/niebieska +/-5%
G01933	12	Plandeka 4x5m lekka/niebieska +/-5%
G01934	10	Plandeka 4x6m lekka/niebieska +/-5%
G01935	6	Plandeka 5x8m lekka/niebieska +/-5%
G01936	4	Plandeka 6x10m lekka/niebieska +/-5%
G01937	3	Plandeka 8x12m lekka/niebieska +/-5%
G01938	2	Plandeka 10x15m lekka/niebieska +/-5%

Kod EAN  
 5901477113383  
 Kod EAN  
 5901477113390  
 Kod EAN  
 5901477113338  
 Kod EAN  
 5901477124938  
 Kod EAN  
 5901477113345  
 Kod EAN  
 5901477124945  
 Kod EAN  
 5901477113352  
 Kod EAN  
 5901477124952  
 Kod EAN  
 5901477113369  
 Kod EAN  
 5901477124969  
 Kod EAN  
 5901477117718

GB Tarpaulin  
 DE Plane  
 RU Тент  
 CZ Plachta  
 SK Plachta  
 HU Ponyva  
 RO Husă

Kod produktu		
G01939	8	Plandeka 4x8m lekka/niebieska +/-5%
G01940	8	Plandeka 5x6m lekka/niebieska +/-5%
G01960	5	Plandeka 6x8m lekka/niebieska +/-5%
G01962	4	Plandeka 6x12m lekka/niebieska +/-5%
G01964	3	Plandeka 8x10m lekka/niebieska +/-5%
G01966	2	Plandeka 10x10m lekka/niebieska +/-5%
G01968	2	Plandeka 10x12m lekka/niebieska +/-5%
G01971	1	Plandeka 15x16m lekka/niebieska +/-5%
G01972	2	Plandeka 12x15m lekka/niebieska +/-5%
G01973	1	Plandeka 12x18m lekka/niebieska +/-5%
G01974	1	Plandeka 15x20m lekka/niebieska +/-5%

80g

wodoodporna  
 łatwo zmywalna  
 pleśniodoporna  
 łatwa w użyciu  
 wyposażona w aluminiowe otwory do mocowania co 1m  
 gramatura 80g/m<sup>2</sup>



Kod EAN  
 5901477124976  
 Kod EAN  
 5901477124983  
 Kod EAN  
 5901477124990  
 Kod EAN  
 5901477125003  
 Kod EAN  
 5901477125010  
 Kod EAN  
 5901477125027  
 Kod EAN  
 5901477125034  
 Kod EAN  
 5901477125041  
 Kod EAN  
 5901477125058  
 Kod EAN  
 5901477125065  
 Kod EAN  
 5901477125072

GB Tarpaulin  
 DE Plane  
 RU Тент  
 CZ Plachta  
 SK Plachta  
 HU Ponyva  
 RO Husă

BEKO	Kod produktu	
Plandeka 2x3m gruba/zielona	G70305	30
Plandeka 2x4m gruba/zielona	G70306	20
Plandeka 3x3m gruba/zielona	G70310	20
Plandeka 3x4m gruba/zielona	G70311	15
Plandeka 3x5m gruba/zielona	G70312	12
Plandeka 4x5m gruba/zielona	G70321	9
Plandeka 4x6m gruba/zielona	G70322	8
Plandeka 4x8m gruba/zielona	G70324	6
Plandeka 5x6m gruba/zielona	G70332	6
Plandeka 5x8m gruba/zielona	G70334	5
Plandeka 6x8m gruba/zielona	G70342	4

Kod EAN  
 5901477125089  
 Kod EAN  
 5901477125096  
 Kod EAN  
 5901477125102  
 Kod EAN  
 5901477125119  
 Kod EAN  
 5901477125126  
 Kod EAN  
 5901477125133  
 Kod EAN  
 5901477125140  
 Kod EAN  
 5901477125157  
 Kod EAN  
 5901477125164  
 Kod EAN  
 5901477125171  
 Kod EAN  
 5901477125188

GB Tarpaulin  
 DE Plane  
 RU Тент  
 CZ Plachta  
 SK Plachta  
 HU Ponyva  
 RO Husă

BEKO	Kod produktu	
Plandeka 6x10m gruba/zielona	G70344	3
Plandeka 6x12m gruba/zielona	G70346	3
Plandeka 8x10m gruba/zielona	G70352	3
Plandeka 8x12m gruba/zielona	G70354	2
Plandeka 10x10m gruba/zielona	G70362	2
Plandeka 10x12m gruba/zielona	G70364	2
Plandeka 10x15m gruba/zielona	G70366	2
Plandeka 12x15m gruba/zielona	G70372	1
Plandeka 12x18m gruba/zielona	G70376	1
Plandeka 15x16m gruba/zielona	G70382	1
Plandeka 15x20m gruba/zielona	G70385	1



120g

wodoodporna  
 łatwo zmywalna  
 pleśnioodporna  
 łatwa w użyciu  
 wyposażona w aluminiowe otwory do mocowania co 1m  
 gramatura 120g/m<sup>2</sup>



Kod EAN  
 5901477125195  
 Kod EAN  
 5901477125201  
 Kod EAN  
 5901477125218  
 Kod EAN  
 5901477125225  
 Kod EAN  
 5901477125232  
 Kod EAN  
 5901477125249  
 Kod EAN  
 5901477125256  
 Kod EAN  
 5901477125263  
 Kod EAN  
 5901477125270  
 Kod EAN  
 5901477125287  
 Kod EAN  
 5901477125294

GB Tarpaulin  
 DE Plane  
 RU Тент  
 CZ Plachta  
 SK Plachta  
 HU Ponyva  
 RO Husă

Kod produktu		
G70505	20	Plandeka 2x3m mega gruba/szara 120G
G70506	15	Plandeka 2x4m mega gruba/szara 120G
G70510	14	Plandeka 3x3m mega gruba/szara 120G
G70511	10	Plandeka 3x4m mega gruba/szara 120G
G70512	8	Plandeka 3x5m mega gruba/szara 120G
G70521	5	Plandeka 4x5m mega gruba/szara 120G
G70522	5	Plandeka 4x6m mega gruba/szara 120G
G70524	4	Plandeka 4x8m mega gruba/szara 120G
G70532	4	Plandeka 5x6m mega gruba/szara 120G
G70534	4	Plandeka 5x8m mega gruba/szara 120G
G70542	4	Plandeka 6x8m mega gruba/szara 120G

Kod EAN  
 5901477125300  
 Kod EAN  
 5901477125317  
 Kod EAN  
 5901477125324  
 Kod EAN  
 5901477125331  
 Kod EAN  
 5901477125348  
 Kod EAN  
 5901477125355  
 Kod EAN  
 5901477125362  
 Kod EAN  
 5901477125379  
 Kod EAN  
 5901477125386  
 Kod EAN  
 5901477125393  
 Kod EAN  
 5901477125409

GB Tarpaulin  
 DE Plane  
 RU Тент  
 CZ Plachta  
 SK Plachta  
 HU Ponyva  
 RO Husă

Kod produktu		
G70544	2	Plandeka 6x10m mega gruba/szara 120G
G70546	2	Plandeka 6x12m mega gruba/szara 120G
G70552	2	Plandeka 8x10m mega gruba/szara 120G
G70554	2	Plandeka 8x12m mega gruba/szara 120G
G70562	2	Plandeka 10x10m mega gruba/szara 120G
G70564	1	Plandeka 10x12m mega gruba/szara 120G
G70566	1	Plandeka 10x15m mega gruba/szara 120G
G70572	1	Plandeka 12x15m mega gruba/szara 120G
G70576	1	Plandeka 12x18m mega gruba/szara 120G
G70582	1	Plandeka 15x16m mega gruba/szara 120G
G70585	1	Plandeka 15x20m mega gruba/szara 120G

200g



wodoodporna  
 łatwo zmywalna  
 pleśnioodporna  
 łatwa w użyciu  
 wyposażona w aluminiowe otwory do mocowania co 1m  
 gramatura 200g/m<sup>2</sup>



Kod EAN  
 5901477124631  
 Kod EAN  
 5901477124648  
 Kod EAN  
 5901477124655  
 Kod EAN  
 5901477124662  
 Kod EAN  
 5901477124679  
 Kod EAN  
 5901477124686  
 Kod EAN  
 5901477124693  
 Kod EAN  
 5901477124709  
 Kod EAN  
 5901477124716  
 Kod EAN  
 5901477124723  
 Kod EAN  
 5901477124730

Kod EAN  
 5901477124747  
 Kod EAN  
 5901477124754  
 Kod EAN  
 5901477124761  
 Kod EAN  
 5901477124778  
 Kod EAN  
 5901477124785  
 Kod EAN  
 5901477124792  
 Kod EAN  
 5901477124808  
 Kod EAN  
 5901477124815  
 Kod EAN  
 5901477124822  
 Kod EAN  
 5901477124839  
 Kod EAN  
 5901477124846

GB Tarpaulin  
 DE Plane  
 RU Тент  
 CZ Plachta  
 SK Plachta  
 HU Ponyva  
 RO Husă

GB Tarpaulin  
 DE Plane  
 RU Тент  
 CZ Plachta  
 SK Plachta  
 HU Ponyva  
 RO Husă

	Kod produktu	
Plandeka 2x3m extra gruba/brązowa 200g	G70705	12
Plandeka 2x4m extra gruba/brązowa 200G	G70706	9
Plandeka 3x3m extra gruba/brązowa 200G	G70710	8
Plandeka 3x4m extra gruba/brązowa 200G	G70711	6
Plandeka 3x5m extra gruba/brązowa 200G	G70712	5
Plandeka 4x5m extra gruba/brązowa 200G	G70721	4
Plandeka 4x6m extra gruba/brązowa 200G	G70722	3
Plandeka 4x8m extra gruba/brązowa 200G	G70724	3
Plandeka 5x6m extra gruba/brązowa 200G	G70732	3
Plandeka 5x8m extra gruba/brązowa 200G	G70734	2
Plandeka 6x8m extra gruba/brązowa 200G	G70742	2

	Kod produktu	
Plandeka 6x10m extra gruba/brązowa 200G	G70744	2
Plandeka 6x12m extra gruba/brązowa 200G	G70746	1
Plandeka 8x10m extra gruba/brązowa 200G	G70752	1
Plandeka 8x12m extra gruba/brązowa 200G	G70754	1
Plandeka 10x10m extra gruba/brązowa 200G	G70762	1
Plandeka 10x12m extra gruba/brązowa 200G	G70764	1
Plandeka 10x15m extra gruba/brązowa 200G	G70766	1
Plandeka 12x15m extra gruba/brązowa 200G	G70772	1
Plandeka 12x18m extra gruba/brązowa 200G	G70776	1
Plandeka 15x16m extra gruba/brązowa 200G	G70782	1
Plandeka 15x20m extra gruba/brązowa 200G	G70785	1



# Wiertnice do gleby / Augers



<b>42.7cc</b>	250 mm
moc nominalna 1.25kw	2800/min
25 : 1	950ml



GB Earth Auger + drill bit  
DE Motorbohrer + Bohrer  
RU бензин экскаватор / земля бурильщик + Сверло  
CZ Půdní motorový vrták  
SK Pôdny motorový vrták  
HU Benzinmotoros földfúró  
RO Motoburghiu



5901477132025

John Gardener Kod produktu **Świder spalnowy do gruntu + wiertło 25cm G81055 1/2cz.**

<b>62cc</b>	100 200 300 mm
moc nominalna 1.4kw	10000/min
25 : 1	1100ml



GB Earth Auger + drill bit  
DE Motorbohrer + Bohrer  
RU бензин экскаватор / земля бурильщик + Сверло  
CZ Půdní motorový vrták  
SK Pôdny motorový vrták  
HU Benzinmotoros földfúró  
RO Motoburghiu



5901477160677

John Gardener Kod produktu **Świder spalnowy + wiertła(10cm,20cm,30cm) + adapter 50cm G84020 4**

<b>62cc</b>	100 200 300 mm
moc nominalna 1.4kw	10000/min
25 : 1	1100ml
500 mm	



GB Earth Auger + drill bit  
DE Motorbohrer + Bohrer  
RU бензин экскаватор / земля бурильщик + Сверло  
CZ Půdní motorový vrták  
SK Pôdny motorový vrták  
HU Benzinmotoros földfúró  
RO Motoburghiu



5901477160684

John Gardener Kod produktu **Świder spalnowy(2os.) + wiertła(10,20,30cm) + adapter 50cm G84021 4**

<b>62cc</b>	320/min
moc nominalna 1.4kw	1100ml
25 : 1	



GB Earth Auger  
DE Motorbohrer  
RU бензин экскаватор / земля бурильщик  
CZ Půdní motorový vrták  
SK Pôdny motorový vrták  
HU Benzinmotoros földfúró  
RO Motoburghiu



5901477160868

John Gardener Kod produktu **Świder spalnowy (bez wiertel) G84024 1**

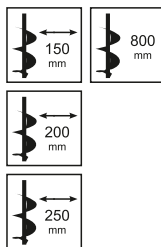

GB Earth Auger + drill bit  
 DE Motorbohrer + Bohrer  
 RU бензин экскаватор / земля бурильщик + Сверло  
 CZ Půdní motorový vrták  
 SK Pôdny motorový vrták  
 HU Benzinmotoros földfúró  
 RO Motoburghiu



Kod EAN  
5901477136276

John Gardener	Kod produktu	
Šwider spaliny do gruntu + wiertło 25cm	H00655	1/2cz.

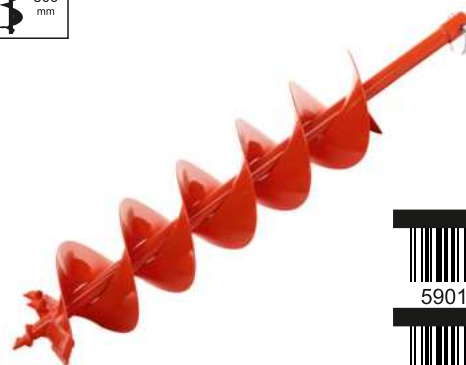

GB Drill  
 DE Bohrer für Erdbohrer Zipper  
 RU Сверло для мотобура  
 CZ Nástavec na zemní vrták  
 SK Nástavec na zemný vrták  
 HU Náhradní vrták k zemnímu vrtáku  
 RO Burghiu



Kod EAN  
5901477178771

Kod EAN  
5901477178788

Kod EAN  
5901477178795

John Gardener	Kod produktu	
Profesjonalne wiertło do świda spalinowego 15x80cm G81056K		1
Profesjonalne wiertło do świda spalinowego 20x80cm G81056L		1
Profesjonalne wiertło do świda spalinowego 25x80cm G81056M		1

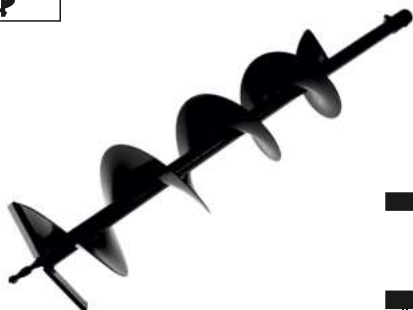
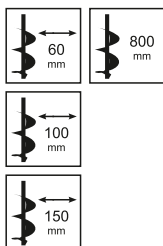

GB Drill  
 DE Bohrer für Erdbohrer Zipper  
 RU Сверло для мотобура  
 CZ Nástavec na zemní vrták  
 SK Nástavec na zemný vrták  
 HU Náhradní vrták k zemnímu vrtáku  
 RO Burghiu



Kod EAN  
5901477160875

Kod EAN  
5901477143465

Kod EAN  
5901477143472

John Gardener	Kod produktu	
Wiertło do świda spalinowego 6x80cm	G81056F	4
Wiertło do świda spalinowego 10x80cm	G81056A	10
Wiertło do świda spalinowego 15x80cm	G81056B	8

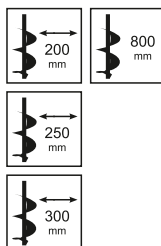

GB Drill  
 DE Bohrer für Erdbohrer Zipper  
 RU Сверло для мотобура  
 CZ Nástavec na zemní vrták  
 SK Nástavec na zemný vrták  
 HU Náhradní vrták k zemnímu vrtáku  
 RO Burghiu



Kod EAN  
5901477143489

Kod EAN  
5901477143496

Kod EAN  
5901477160882

John Gardener	Kod produktu	
Wiertło do świda spalinowego 20x80cm	G81056C	6
Wiertło do świda spalinowego 25x80cm	G81056D	4
Wiertło do świda spalinowego 30x80cm	G81056G	2

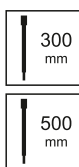

GB Earth auger shock absorber  
 DE Stoßdämpfer für Erdbohrer  
 RU Амортизатор земляного бура  
 CZ Tlumič zemního šneku  
 SK Tlmič zemného šneku  
 HU Földcsiga lengéscsillapító  
 RO Амортизатор земляного бура



Kod EAN  
5901477180965

John Gardener	Kod produktu	
Amortyzator – sprzężyna do świda spalinowego 210/20mm	G81056X	6

GB Adapter for earth auger  
 DE Adapter für Motorbohrer  
 RU Адаптер для Мотобур  
 CZ Prodlužovací nástavec pro zemní vrták  
 SK Predĺžovací nástavec pre zemný vrták  
 HU Fűrészár  
 RO Adaptor



Kod EAN  
5901477143458

Kod EAN  
5901477160844

John Gardener	Kod produktu	
Adapter do świda spalinowego 30cm	G81056	20
Adapter do świda spalinowego 50cm	G84022	20



GB Reduce speed asy for earth auger  
 DE Führungsschiene  
 RU Передача для бензин экскаватора  
 CZ Převodovka pro zemní vrták  
 SK Prevodovka pre zemný vrták  
 HU Földfúró áttét  
 RO Transmisie



Kod EAN  
5901477160851

John Gardener	Kod produktu	
Przekładnia świda spalinowego typu prostego	G84023	10



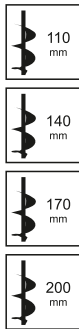

GB Gimlet to the soil  
DE Handbohrer für den Erdboden  
RU Ручной почвенный бур  
CZ Ruční vrták do půdy  
SK Ručné vrták do pôdy  
HU Kézi talajfúró  
RO Sfredel manual pt. pământ

John Gardener	Kod produktu	
Świder ręczny do gleby 110mm	G66511	100
Świder ręczny do gleby 140mm	G66512	100
Świder ręczny do gleby 170mm	G66513	100
Świder ręczny do gleby 200mm	G66514	50

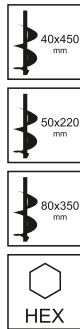

GB Gimlet to the soil  
DE Handbohrer für den Erdboden  
RU Ручной почвенный бур  
CZ Ruční vrták do půdy  
SK Ručné vrták do pôdy  
HU Kézi talajfúró  
RO Sfredel manual pt. pământ



John Gardener	Kod produktu	
Wiertło ogrodowe – świder do gleby 4x45cm	G72071	50
Wiertło ogrodowe – świder do gleby 5x22cm	G72072	40
Wiertło ogrodowe – świder do gleby 8x35cm	G72073	30

## Łopaty, szpadle, widły i grabie / Shovels, spades, forks and rakes

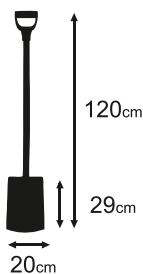

GB Spade  
DE Rodespaten  
RU Заступ  
CZ Lisovaný rýč kalená  
SK Lisovaný rýľ kalená  
HU Ásó, sajított-edzett  
RO Hârteț cu coadă

John Gardener	Kod produktu	
Szpadel prosty trzon metalowy	G66501	5

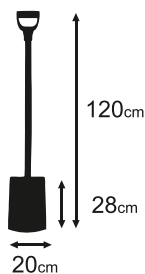

GB Spade  
DE Rodespaten  
RU Заступ  
CZ Lisovaný rýč kalená  
SK Lisovaný rýľ kalená  
HU Ásó, sajított-edzett  
RO Hârteț cu coadă

John Gardener	Kod produktu	
Szpadel ostry trzon metalowy	G66502	5

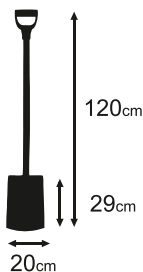

GB Spade  
DE Rodespaten  
RU Заступ  
CZ Lisovaný rýč kalená  
SK Lisovaný rýč kalená  
HU Ásó, sajtolé-edzett  
RO Hârlet cu coadă



Kod EAN  
5901477140372

**Szpadel ogrodowy wzmacniony oprawiony**      Kod produktu **G66504**      5

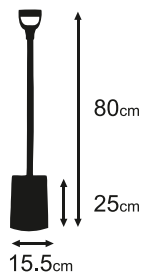

GB Spade  
DE Rodespaten  
RU Заступ  
CZ Lisovaný rýč kalená  
SK Lisovaný rýč kalená  
HU Ásó, sajtolé-edzett  
RO Hârlet cu coadă



Kod EAN  
5901477140426

**Saperka trzon metalowy**      Kod produktu **G66509**      5

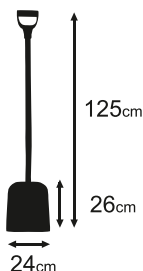

GB Shovel  
DE Schaufel  
RU Лопата совковая песочная  
CZ Osazený rýč pískový  
SK Osadený rýč pieskový  
HU Homoklapát  
RO Lopată pt. nisip



Kod EAN  
5901477140334

**Łopata piaskowa trzon metalowy**      Kod produktu **G66500**      5

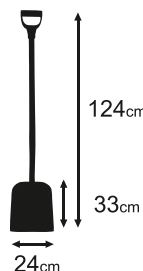

GB Shovel  
DE Schaufel  
RU Лопата совковая песочная  
CZ Osazený rýč pískový  
SK Osadený rýč pieskový  
HU Homoklapát  
RO Lopată pt. nisip



Kod EAN  
5901477140433

**Łopata węglowa trzon metalowy**      Kod produktu **G66510**      10

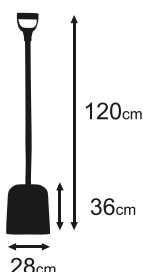

GB Shovel  
DE Schaufel  
RU Лопата совковая песочная  
CZ Osazený rýč pískový  
SK Osadený rýč pieskový  
HU Homoklapát  
RO Lopată pt. nisip



Kod EAN  
5901477144936

**Łopata węglowa trzon drewniany DUŻA**      Kod produktu **G66520**      10

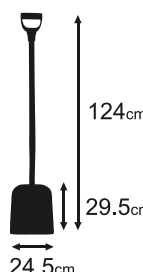

GB Shovel  
DE Schaufel  
RU Лопата совковая песочная  
CZ Osazený rýč pískový  
SK Osadený rýč pieskový  
HU Homoklapát  
RO Lopată pt. nisip



Kod EAN  
5901477172304

**Łopata uniwersalna lekka oprawna 125cm**      Kod produktu **G66525**      6







GB Garden hoe  
DE Garten Handhacke  
RU Тяпка  
CZ Motyčka  
SK Motyčka  
HU Kerti kapa  
RO Sapaliga

Kod EAN  
5901477172267

Kod produktu 5  
Motyka serce - pazurki dł. 100cm G66521





GB Garden hoe  
DE Garten Handhacke  
RU Тяпка  
CZ Motyčka  
SK Motyčka  
HU Kerti kapa  
RO Sapaliga

Kod EAN  
5901477172274

Kod produktu 5  
Motyka łopatką - pazurki dł. 100cm G66522





GB Garden hoe  
DE Garten Handhacke  
RU Тяпка  
CZ Motyčka  
SK Motyčka  
HU Kerti kapa  
RO Sapaliga

Kod EAN  
5901477172281

Kod produktu 5  
Motyka trapezowa sz.16cm dł. 100cm G66523









GB Rake  
DE Rechen  
RU Грабли  
CZ Hrábě  
SK Hrable  
HU Gereblye  
RO Greblă

Kod EAN  
5901477140389

Kod produktu 5  
Grabie 12-zębne oprawione G66505

GB Rake  
DE Rechen  
RU Грабли  
CZ Hrábě  
SK Hrable  
HU Gereblye  
RO Greblă

Kod EAN  
5901477140396

Kod produktu 5  
Grabie 14-zębne oprawione G66506





GB Rake  
DE Rechen  
RU Грабли  
CZ Hrábě  
SK Hrable  
HU Gereblye  
RO Greblă

Kod EAN  
5901477140402

Kod produktu 5  
Grabie 16-zębne oprawione G66507

18



GB Rake  
DE Rechen  
RU Грабли  
CZ Hrábě  
SK Hrable  
HU Gereblye  
RO Greblă



Kod EAN  
5901477140419

**Grabie 18-zębne oprawione** Kod produktu **G66508** 5

GB Digging fork  
DE Grabegabel  
RU Вилы свекловичные кованые  
CZ Zahradnické vidlice  
SK Záhradnícke vidlica  
HU Vasvilla  
RO Furcă pt. grădină



Kod EAN  
5901477144844

**Widły gospodarcze 3-zębne trzon metalowy** Kod produktu **G66515** 5

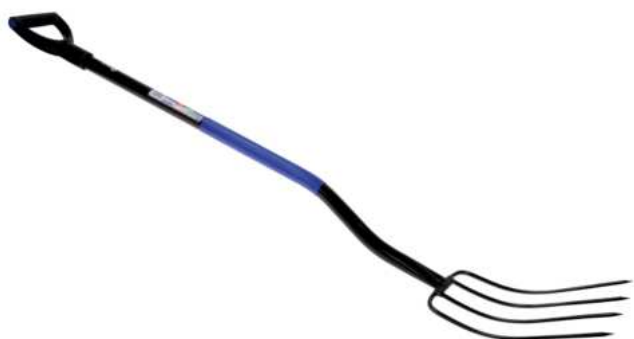

GB Digging fork  
DE Grabegabel  
RU Вилы свекловичные кованые  
CZ Zahradnické vidlice  
SK Záhradnícke vidlica  
HU Vasvilla  
RO Furcă pt. grădină



Kod EAN  
5901477144851

**Widły gospodarcze 4-zębne trzon metalowy** Kod produktu **G66516** 5



GB Digging fork  
DE Grabegabel  
RU Вилы свекловичные кованые  
CZ Zahradnické vidlice  
SK Záhradnícke vidlica  
HU Vasvilla  
RO Furcă pt. grădină



Kod EAN  
5901477144868

**Widły ogrodowe trzon metalowy** Kod produktu **G66517** 5



GB Digging fork  
DE Grabegabel  
RU Вилы свекловичные кованые  
CZ Zahradnické vidlice  
SK Záhradnícke vidlica  
HU Vasvilla  
RO Furcă pt. grădină



Kod EAN  
5901477129162

**Widły gospodarcze 4-zębne zielone** Kod produktu **G72050** 12

14



GB Rake  
DE Rechen  
RU Грабли  
CZ Hrábě  
SK Hrable  
HU Gereblye  
RO Greblă



Kod EAN  
5901477144875

**Grabie ergo 14-zębne trzon metalowy** Kod produktu **G66518** 1



16



M



ilość zębów  
23



GB Rake  
DE Rechen  
RU Грабли  
CZ Hrábě  
SK Hrable  
HU Gereblye  
RO Greblă



Kod EAN  
5901477144882

**Grabie ergo 16-zębne trzon metalowy** Kod produktu **G66519** 1

GB Spring rake  
DE Landschaftsbesen  
RU Грабли веерные  
CZ Hrábičky  
SK Hrabličky  
HU Kerti gereblye  
RO Grebla de gradina



Kod EAN  
5901477177484

**Grabie do liści M (bez trzonka - montaż uniwersalny)** Kod produktu **G66531** 70

L



XL



ilość zębów  
20



ilość zębów  
27



GB Spring rake  
DE Landschaftsbesen  
RU Грабли веерные  
CZ Hrábičky  
SK Hrabličky  
HU Kerti gereblye  
RO Grebla de gradina



Kod EAN  
5901477177491

**Grabie do liści L (bez trzonka - montaż uniwersalny)** Kod produktu **G66532** 1

GB Spring rake  
DE Landschaftsbesen  
RU Грабли веерные  
CZ Hrábičky  
SK Hrabličky  
HU Kerti gereblye  
RO Grebla de gradina



Kod EAN  
5901477177507

**Grabie do liści XL (bez trzonka - montaż uniwersalny)** Kod produktu **G66533** 1

18



140  
cm



GB Rake  
DE Rechen  
RU Грабли  
CZ Hrábě  
SK Hrable  
HU Gereblye  
RO Greblă



Kod EAN  
5901477177729

**Grabie do siana 18 zębne (bez trzonka)** Kod produktu **G66534** 5

GB Wooden handle  
DE Schaufelstiel P-Griff  
RU Черенок для лопат  
CZ Násada na lopatu  
SK Násada na lopatu  
HU Lapátnyel  
RO Coada de lopata cu maner



Kod EAN  
5901477177545

**Trzonek drewniany z mocowaniem KLIK (grabie do liści)** Kod produktu **G66534** 5

# Łopaty do śniegu / Snow Shovels

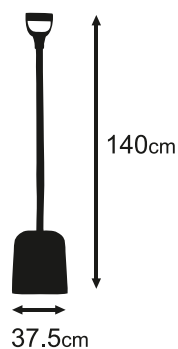
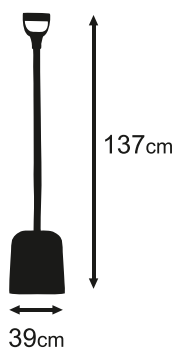

GB Shovel  
DE Kohlschaufel  
RU Лопата угольная  
CZ Úhlový rýč číslo  
SK Úhlový rýč číslo  
HU Szeneslapát  
RO Lopată pt. cărbune



Kod produktu 4  
Łopata do śniegu plastikowa t/aluminiowy całoroczna D00001

GB Shovel  
DE Kohlschaufel  
RU Лопата угольная  
CZ Úhlový rýč číslo  
SK Úhlový rýč číslo  
HU Szeneslapát  
RO Lopată pt. cărbune



Kod produktu 3  
Łopata uniwersalna aluminiowa do zboża śniegu D00002



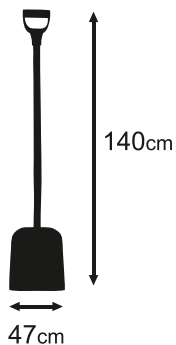

GB Shovel  
DE Kohlenschaufel  
RU Лопата угольная  
CZ Úhlový rýč číslo  
SK Úhlový rýč číslo  
HU Szeneslapát  
RO Lopată pt. cărbune



Kod EAN  
5901497400012

**Łopata do śniegu aluminiowa BIG**      Kod produktu **D00003**      2

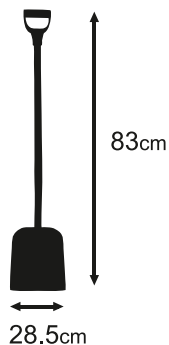

GB Shovel  
DE Kohlenschaufel  
RU Лопата угольная  
CZ Úhlový rýč číslo  
SK Úhlový rýč číslo  
HU Szeneslapát  
RO Lopată pt. cărbune



Kod EAN  
5901497400197

**Łopata śniegowa samochodowa**      Kod produktu **D00004**      1

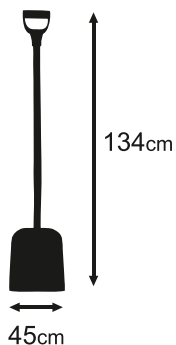

GB Shovel  
DE Kohlenschaufel  
RU Лопата угольная  
CZ Úhlový rýč číslo  
SK Úhlový rýč číslo  
HU Szeneslapát  
RO Lopată pt. cărbune



Kod EAN  
5901497400845

**Łopata do śniegu AL MIX**      Kod produktu **D00005**      5

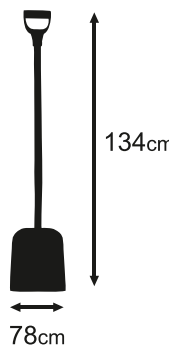

GB Shovel  
DE Kohlenschaufel  
RU Лопата угольная  
CZ Úhlový rýč číslo  
SK Úhlový rýč číslo  
HU Szeneslapát  
RO Lopată pt. cărbune



Kod EAN  
5901497400852

**Zgarniacz do śniegu "rodzinny"**      Kod produktu **D00006**      3

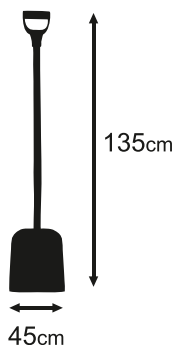

GB Shovel  
DE Kohlenschaufel  
RU Лопата угольная  
CZ Úhlový rýč číslo  
SK Úhlový rýč číslo  
HU Szeneslapát  
RO Lopată pt. cărbune



Kod EAN  
5901477183997

**Łopata uniwersalna 45cm do śniegu**      Kod produktu **D00008**      10



GB Shovel handle  
DE Schaufelstiel  
RU Ручка лопаты  
CZ Rukojeť lopaty  
SK Rukoväť lopaty  
HU Lapát nyél  
RO Mâner de lopată



Kod EAN  
5901477158148

**Rączka do łopaty fi 32mm**      Kod produktu **D00007**      1

# Miotły i szczotki / Brooms & Brushes



30  
cm



GB Broom  
DE Strassenbesen  
RU Метла  
CZ Metla  
SK Metla  
HU Partvis  
RO Matura



5901477134166

**EKO** Kod produktu **Ulicówka 30cm** G66037 10

40  
cm



GB Broom  
DE Strassenbesen  
RU Метла  
CZ Metla  
SK Metla  
HU Partvis  
RO Matura



5901477134173

**EKO** Kod produktu **Ulicówka 40cm** G66038 10

50  
cm



GB Broom  
DE Strassenbesen  
RU Метла  
CZ Metla  
SK Metla  
HU Partvis  
RO Matura



5901477134180

**EKO** Kod produktu **Ulicówka 50cm** G66039 10

60  
cm



GB Broom  
DE Strassenbesen  
RU Метла  
CZ Metla  
SK Metla  
HU Partvis  
RO Matura



5901477134197

**EKO** Kod produktu **Ulicówka 60cm** G66040 10

35x85mm



GB Brush for footpaths  
DE Bürste für Gehwege  
RU Щетка для пешеходных дорожек  
CZ Kartáč na pěšinky  
SK Kefa na chodníky  
HU Kefe gyalogutakhoz  
RO Perie pentru poteci



5901477181993

**EKO** Kod produktu **Szczotka drucziana ze skrobakiem do kostki brukowej, drewno** K00036 25

35x80mm



GB Brush for footpaths  
DE Bürste für Gehwege  
RU Щетка для пешеходных дорожек  
CZ Kartáč na pěšinky  
SK Kefa na chodníky  
HU Kefe gyalogutakhoz  
RO Perie pentru poteci



5901477182006

**EKO** Kod produktu **Szczotka drucziana ze skrobakiem do kostki brukowej, plast.** K00037 10



# Rękawice / Gloves



rozmiar/size **9**

Opakowanie **12** par

GB Working gloves  
DE Arbeitshandschuh  
RU Рабочие перчатки  
CZ Pracovní rukavice  
SK Pracovné rukavice  
HU Védőkesztyű  
RO Mănuși de lucru

Kod EAN  
5901477122255

Kod produktu **G73502A** 600

**Rękawice wampirki rozmiar 9/czerwone/**

rozmiar/size **9**

Opakowanie **12** par

GB Working gloves  
DE Arbeitshandschuh  
RU Рабочие перчатки  
CZ Pracovní rukavice  
SK Pracovné rukavice  
HU Védőkesztyű  
RO Mănuși de lucru

Kod EAN  
5901477131974

Kod produktu **G73502C** 600

**Rękawice wampirki rozmiar 9/niebieskie/**

rozmiar/size **9**

Opakowanie **12** par

GB Working gloves  
DE Arbeitshandschuh  
RU Рабочие перчатки  
CZ Pracovní rukavice  
SK Pracovné rukavice  
HU Védőkesztyű  
RO Mănuși de lucru

Kod EAN  
5901477147128

Kod produktu **G73503** 600

**Rękawice robocze dziane naturalne**

rozmiar/size **9**

Opakowanie **12** par

GB Working gloves  
DE Arbeitshandschuh  
RU Рабочие перчатки  
CZ Pracovní rukavice  
SK Pracovné rukavice  
HU Védőkesztyű  
RO Mănuși de lucru

Kod EAN  
5901477147135

Kod produktu **G73504** 600

**Rękawice robocze dziane naturalne nakrapiane**

rozmiar/size **6**

Opakowanie **12** par

GB Working gloves  
DE Arbeitshandschuh  
RU Рабочие перчатки  
CZ Pracovní rukavice  
SK Pracovné rukavice  
HU Védőkesztyű  
RO Mănuși de lucru

Kod EAN  
5901477178979

Kod produktu **G73507** 300

**Rękawice robocze ogrodowe damskie r.6**

rozmiar/size **8**

Opakowanie **12** par

GB Working gloves  
DE Arbeitshandschuh  
RU Рабочие перчатки  
CZ Pracovní rukavice  
SK Pracovné rukavice  
HU Védőkesztyű  
RO Mănuși de lucru

Kod EAN  
5901477122316

Kod produktu **G73511** 300

**Rękawice ochronne GEKO r.8/czarne/**

rozmiar/size **9**

Opakowanie **12** par

GB Working gloves  
DE Arbeitshandschuh  
RU Рабочие перчатки  
CZ Pracovní rukavice  
SK Pracovné rukavice  
HU Védőkesztyű  
RO Mănuși de lucru

Kod EAN  
5901477131981

Kod produktu **G73512** 300

**Rękawice ochronne GEKO r.9/czarne/**

rozmiar/size **10**

Opakowanie **12** par

GB Working gloves  
DE Arbeitshandschuh  
RU Рабочие перчатки  
CZ Pracovní rukavice  
SK Pracovné rukavice  
HU Védőkesztyű  
RO Mănuși de lucru

Kod EAN  
5901477122330

Kod produktu **G73513** 300

**Rękawice ochronne GEKO r.10/czarne/**

rozmiar/size **8**



Opakowanie **12** par

GB Working gloves  
DE Arbeitshandschuh  
RU Рабочие перчатки  
CZ Pracovní rukavice  
SK Pracovné rukavice  
HU Védőkesztyű  
RO Mănuși de lucru

Kod EAN  
5901477178474

Kod produktu **G73521** 300

**Rękawice ochronne GEKO r.8/biało-szare/**

rozmiar/size **9**



Opakowanie **12** par

GB Working gloves  
DE Arbeitshandschuh  
RU Рабочие перчатки  
CZ Pracovní rukavice  
SK Pracovné rukavice  
HU Védőkesztyű  
RO Mănuși de lucru

Kod EAN  
5901477122347

Kod produktu **G73522** 300

**Rękawice ochronne GEKO r.9/biało-szare/**

rozmiar/size **10**



Opakowanie **12** par

GB Working gloves  
DE Arbeitshandschuh  
RU Рабочие перчатки  
CZ Pracovní rukavice  
SK Pracovné rukavice  
HU Védőkesztyű  
RO Mănuși de lucru

Kod EAN  
5901477122354

Kod produktu **G73523** 300

**Rękawice ochronne GEKO r.10/biało-szare/**

rozmiar/size **7**



Opakowanie **12** par

GB Working gloves  
DE Arbeitshandschuh  
RU Рабочие перчатки  
CZ Pracovní rukavice  
SK Pracovné rukavice  
HU Védőkesztyű  
RO Mănuși de lucru

Kod EAN  
5901477178481

Kod produktu **G73530** 240

**Rękawice ochronne GEKO r.7/latex czerwone/**

rozmiar/size **8**



Opakowanie **12** par

GB Working gloves  
DE Arbeitshandschuh  
RU Рабочие перчатки  
CZ Pracovní rukavice  
SK Pracovné rukavice  
HU Védőkesztyű  
RO Mănuși de lucru

Kod EAN  
5901477122361

Kod produktu **G73531** 240

**Rękawice ochronne GEKO r.8/latex czerwone/**

rozmiar/size **9**



Opakowanie **12** par

GB Working gloves  
DE Arbeitshandschuh  
RU Рабочие перчатки  
CZ Pracovní rukavice  
SK Pracovné rukavice  
HU Védőkesztyű  
RO Mănuși de lucru

Kod EAN  
5901477122378

Kod produktu **G73532** 240

**Rękawice ochronne GEKO r.9/latex czerwone/**

rozmiar/size **10**



Opakowanie **12** par

GB Working gloves  
DE Arbeitshandschuh  
RU Рабочие перчатки  
CZ Pracovní rukavice  
SK Pracovné rukavice  
HU Védőkesztyű  
RO Mănuși de lucru

Kod EAN  
5901477122385

Kod produktu **G73533** 240

**Rękawice ochronne GEKO r.10/latex czerwone/**

rozmiar/size **11**



Opakowanie **12** par

GB Working gloves  
DE Arbeitshandschuh  
RU Рабочие перчатки  
CZ Pracovní rukavice  
SK Pracovné rukavice  
HU Védőkesztyű  
RO Mănuși de lucru

Kod EAN  
5901477178498

Kod produktu **G73534** 240

**Rękawice ochronne GEKO r.11/latex czerwone/**

rozmiar/size **9**



Opakowanie **12** par

GB Working gloves  
DE Arbeitshandschuh  
RU Рабочие перчатки  
CZ Pracovní rukavice  
SK Pracovné rukavice  
HU Védőkesztyű  
RO Mănuși de lucru

Kod EAN  
5901477122392

Kod produktu **G73542** 300

**Rękawice ochronne GEKO r.9/białe/**

rozmiar/size **10**



Opakowanie **12** par

GB Working gloves  
DE Arbeitshandschuh  
RU Рабочие перчатки  
CZ Pracovní rukavice  
SK Pracovné rukavice  
HU Védőkesztyű  
RO Mănuși de lucru

Kod EAN  
5901477122408

Kod produktu **G73543** 300

**Rękawice ochronne GEKO r.10/białe/**

rozmiar/size **9**



Opakowanie **12** par

GB Working gloves  
DE Arbeitshandschuh  
RU Рабочие перчатки  
CZ Pracovní rukavice  
SK Pracovné rukavice  
HU Védőkesztyű  
RO Mănuși de lucru

Kod EAN  
5901477122415

Kod produktu **G73552** 300

**Rękawice ochronne GEKO r.9/żółte/**

rozmiar/size **10**



Opakowanie **12** par

GB Working gloves  
DE Arbeitshandschuh  
RU Рабочие перчатки  
CZ Pracovní rukavice  
SK Pracovné rukavice  
HU Védőkesztyű  
RO Mănuși de lucru

Kod EAN  
5901477122422

Kod produktu **G73553** 300

**Rękawice ochronne GEKO r.10/żółte/**



rozmiar/size **9**



Opakowanie **12** par

GB Working gloves  
DE Arbeitshandschuh  
RU Рабочие перчатки  
CZ Pracovní rukavice  
SK Pracovné rukavice  
HU Védőkesztyű  
RO Mănuși de lucru

Kod EAN  
5901477122453

Kod produktu **G73572 240**

**Rękawice ochronne GEKON r.9/latex,czarne grube/**

rozmiar/size **10**



Opakowanie **12** par

GB Working gloves  
DE Arbeitshandschuh  
RU Рабочие перчатки  
CZ Pracovní rukavice  
SK Pracovné rukavice  
HU Védőkesztyű  
RO Mănuși de lucru

Kod EAN  
5901477122460

Kod produktu **G73573 240**

**Rękawice ochronne GEKON r.10/latex,czarne grube/**

rozmiar/size **8**



Opakowanie **12** par

GB Working gloves  
DE Arbeitshandschuh  
RU Рабочие перчатки  
CZ Pracovní rukavice  
SK Pracovné rukavice  
HU Védőkesztyű  
RO Mănuși de lucru

Kod EAN  
5901477147180

Kod produktu **G73585 480**

**Rękawice robocze ocieplane zimowe GREEN r.8**

rozmiar/size **9**



Opakowanie **12** par

GB Working gloves  
DE Arbeitshandschuh  
RU Рабочие перчатки  
CZ Pracovní rukavice  
SK Pracovné rukavice  
HU Védőkesztyű  
RO Mănuși de lucru

Kod EAN  
5901477147197

Kod produktu **G73586 480**

**Rękawice robocze ocieplane zimowe GREEN r.9**

rozmiar/size **10**



Opakowanie **12** par

GB Working gloves  
DE Arbeitshandschuh  
RU Рабочие перчатки  
CZ Pracovní rukavice  
SK Pracovné rukavice  
HU Védőkesztyű  
RO Mănuși de lucru

Kod EAN  
5901477147173

Kod produktu **G73587 480**

**Rękawice robocze ocieplane zimowe GREEN r.10**

rozmiar/size **8**



Opakowanie **12** par

GB Working gloves  
DE Arbeitshandschuh  
RU Рабочие перчатки  
CZ Pracovní rukavice  
SK Pracovné rukavice  
HU Védőkesztyű  
RO Mănuși de lucru

Kod EAN  
5901477147210

Kod produktu **G73590 480**

**Rękawice robocze ocieplane zimowe ORANGE r.8**

rozmiar/size **9**



Opakowanie **12** par

GB Working gloves  
DE Arbeitshandschuh  
RU Рабочие перчатки  
CZ Pracovní rukavice  
SK Pracovné rukavice  
HU Védőkesztyű  
RO Mănuși de lucru

Kod EAN  
5901477147227

Kod produktu **G73591 480**

**Rękawice robocze ocieplane zimowe ORANGE r.9**

rozmiar/size **10**



Opakowanie **12** par

GB Working gloves  
DE Arbeitshandschuh  
RU Рабочие перчатки  
CZ Pracovní rukavice  
SK Pracovné rukavice  
HU Védőkesztyű  
RO Mănuși de lucru

Kod EAN  
5901477147203

Kod produktu **G73592 480**

**Rękawice robocze ocieplane zimowe ORANGE r.10**

rozmiar/size **8**



Opakowanie **12** par

GB Working gloves  
DE Arbeitshandschuh  
RU Рабочие перчатки  
CZ Pracovní rukavice  
SK Pracovné rukavice  
HU Védőkesztyű  
RO Mănuși de lucru

Kod EAN  
5901477147159

Kod produktu **G73595 240**

**Rękawice robocze ocieplane zimowe BLUE r.8**

rozmiar/size **9**



Opakowanie **12** par

GB Working gloves  
DE Arbeitshandschuh  
RU Рабочие перчатки  
CZ Pracovní rukavice  
SK Pracovné rukavice  
HU Védőkesztyű  
RO Mănuși de lucru

Kod EAN  
5901477147166

Kod produktu **G73596 240**

**Rękawice robocze ocieplane zimowe BLUE r.9**

rozmiar/size **10**



Opakowanie **12** par

GB Working gloves  
DE Arbeitshandschuh  
RU Рабочие перчатки  
CZ Pracovní rukavice  
SK Pracovné rukavice  
HU Védőkesztyű  
RO Mănuși de lucru

Kod EAN  
5901477147142

Kod produktu **G73597 240**

**Rękawice robocze ocieplane zimowe BLUE r.10**



Opakowanie **100** par

GB Garden gloves  
DE Gartenhandschuhe  
RU Садовые перчатки  
CZ Zahradnické rukavice  
SK Záhradnícke rukavice  
HU Kertészkesztyűk  
RO Mănuși de grădinărit

Kod EAN  
5901477134487

Kod produktu **G73599 100**

**Rękawice ogrodowe z pazurkami**

# Wałki przekaźnika mocy / PTO Shafts



rura-T

80  
cm

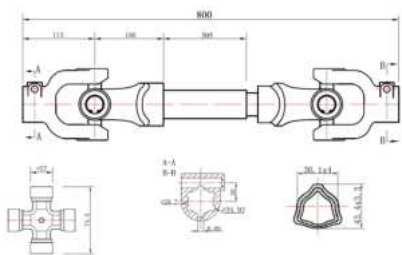

GB PTO shaft lemon tube  
DE Gelenkwelle Zapfwelle  
RU Шарнирно-телескопические валы  
CZ Kloubova hřidel  
SK Kľbový hriadel  
HU Öntözöpisztoly  
RO Vand Arbore cardanic cu dlichet



Kod EAN

5901477126932

**Walek przekaźnika mocy 80cm (rura-T)**      **G72300**      **1**

rura-T

100  
cm

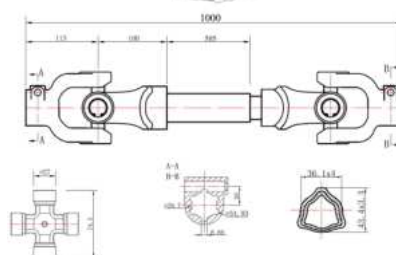

GB PTO shaft lemon tube  
DE Gelenkwelle Zapfwelle  
RU Шарнирно-телескопические валы  
CZ Kloubova hřidel  
SK Kľbový hriadel  
HU Öntözöpisztoly  
RO Vand Arbore cardanic cu dlichet



Kod EAN

5901477123832

**Walek przekaźnika mocy 100cm (rura-T)**      **G72301**      **1**

rura-T

120  
cm

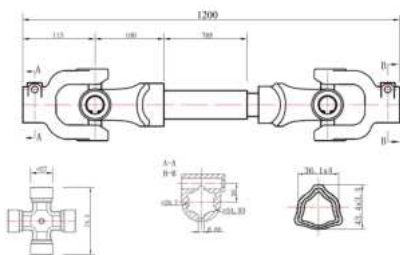

GB PTO shaft lemon tube  
DE Gelenkwelle Zapfwelle  
RU Шарнирно-телескопические валы  
CZ Kloubova hřidel  
SK Kľbový hriadel  
HU Öntözöpisztoly  
RO Vand Arbore cardanic cu dlichet



Kod EAN

5901477126710

**Walek przekaźnika mocy 120cm (rura-T)**      **G72302**      **1**

rura-T

75  
cm



GB PTO shaft lemon tube  
DE Gelenkwelle Zapfwelle  
RU Шарнирно-телескопические валы  
CZ Kloubova hřidel  
SK Kľbový hriadel  
HU Öntözöpisztoly  
RO Vand Arbore cardanic cu dlichet



Kod EAN

5901477123818

**Walek przekaźnika mocy 75cm (rura-T)**      **G72303**      **1**



rura-T  
90  
cm

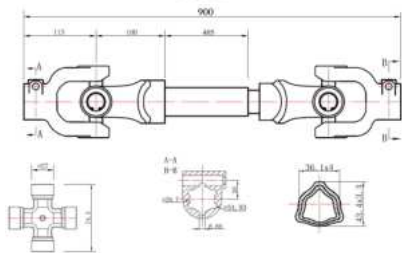

GB PTO shaft lemon tube  
DE Gelenkwelle Zapfwelle  
RU Шарнирно-телескопические валы  
CZ Kloubova hřídel  
SK Kľobový hriadel  
HU Öntözöpisztoly  
RO Vand Arbore cardanic cu dichtet



Kod EAN  
5901477123825

**Walek przekaźnika mocy 90cm (rura-T)**      Kod produktu **G72304**      1

rura-T  
110  
cm

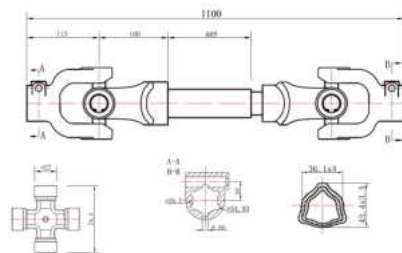

GB PTO shaft lemon tube  
DE Gelenkwelle Zapfwelle  
RU Шарнирно-телескопические валы  
CZ Kloubova hřídel  
SK Kľobový hriadel  
HU Öntözöpisztoly  
RO Vand Arbore cardanic cu dichtet



Kod EAN  
5901477123849

**Walek przekaźnika mocy 110cm (rura-T)**      Kod produktu **G72305**      1

frez  
80  
cm

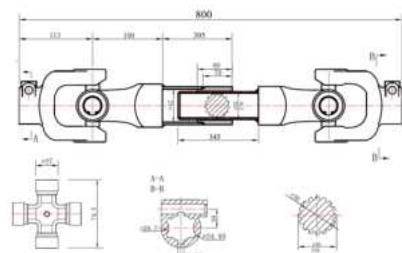

GB PTO shaft lemon tube  
DE Gelenkwelle Zapfwelle  
RU Шарнирно-телескопические валы  
CZ Kloubova hřídel  
SK Kľobový hriadel  
HU Öntözöpisztoly  
RO Vand Arbore cardanic cu dichtet



Kod EAN  
5901477123757

**Walek przekaźnika mocy 80cm (frez)**      Kod produktu **G72310**      1

frez  
100  
cm

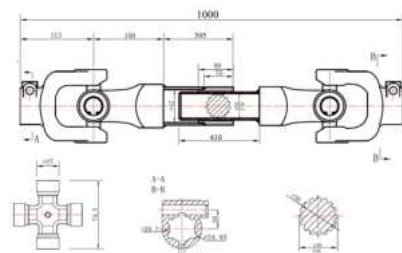

GB PTO shaft lemon tube  
DE Gelenkwelle Zapfwelle  
RU Шарнирно-телескопические валы  
CZ Kloubova hřídel  
SK Kľobový hriadel  
HU Öntözöpisztoly  
RO Vand Arbore cardanic cu dichtet



Kod EAN  
5901477123764

**Walek przekaźnika mocy 100cm (frez)**      Kod produktu **G72311**      1

frez  
120  
cm

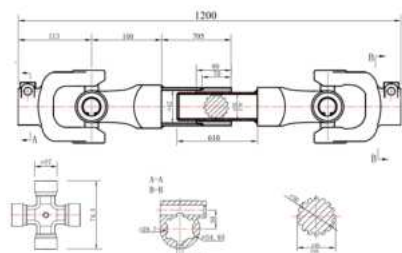

GB PTO shaft lemon tube  
DE Gelenkwelle Zapfwelle  
RU Шарнирно-телескопические валы  
CZ Kloubova hřídel  
SK Kľobový hriadel  
HU Öntözöpisztoly  
RO Vand Arbore cardanic cu dichtet



Kod EAN  
5901477123771

**Walek przekaźnika mocy 120cm (frez)**      Kod produktu **G72312**      1

frez  
75  
cm

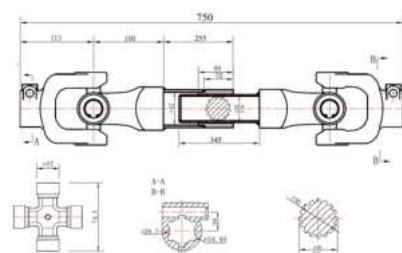

GB PTO shaft lemon tube  
DE Gelenkwelle Zapfwelle  
RU Шарнирно-телескопические валы  
CZ Kloubova hřídel  
SK Kľobový hriadel  
HU Öntözöpisztoly  
RO Vand Arbore cardanic cu dichtet



Kod EAN  
5901477123740

**Walek przekaźnika mocy 75cm (frez)**      Kod produktu **G72313**      1



frez  
90  
cm



GB PTO shaft lemon tube  
DE Gelenkwelle Zapfwelle  
RU Шарнирно-телескопические валы  
CZ Kloubova hřídel  
SK Kĺbový hriadel  
HU Öntözõpisztoly  
RO Vand Arbore cardanic cu dıchet

Kod EAN  
5901477143342

**Walek przekaźnika mocy 90cm (frez)** G72314 1



frez  
110  
cm



GB PTO shaft lemon tube  
DE Gelenkwelle Zapfwelle  
RU Шарнирно-телескопические валы  
CZ Kloubova hřídel  
SK Kĺbový hriadel  
HU Öntözõpisztoly  
RO Vand Arbore cardanic cu dıchet

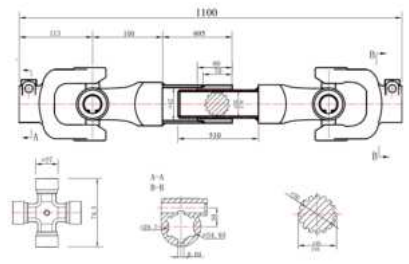

Kod EAN  
5901477123795

**Walek przekaźnika mocy 110cm (frez)** G72315 1

# Koła, dętki, opony / Wheels, tubes, tires



3.50/4.00 2PR 2.1bar 136kg

GB Rubber wheels  
DE Räder  
RU Колеса  
CZ Gumové kolo  
SK Gumové koleso  
HU Kerék  
RO Roată din cauciuc

Kod EAN  
5901477120152

**Koło do wózka 3.50-4/2PR** G71002 10

4.00/4.00 2PR 2.5bar 136kg

GB Rubber wheels  
DE Räder  
RU Колеса  
CZ Gumové kolo  
SK Gumové koleso  
HU Kerék  
RO Roată din cauciuc

Kod EAN  
5901477120190

**Koło do wózka 4.00-4/2PR (średnie)** G71005 10

4.00/6.00 2PR 2.1bar 136kg

GB Rubber wheels  
DE Räder  
RU Колеса  
CZ Gumové kolo  
SK Gumové koleso  
HU Kerék  
RO Roată din cauciuc

Kod EAN  
5901477120213

**Koło do taczki (małe) 4.00-6/2PR** G71006 10

4.00/8.00 2PR 2.1bar 210kg

GB Rubber wheels  
DE Räder  
RU Колеса  
CZ Gumové kolo  
SK Gumové koleso  
HU Kerék  
RO Roată din cauciuc

Kod EAN  
5901477113666

**Koło do taczki 4.00-8/2PR/czerwona felga/** G71012 1



3.00/4.00  
2PR  
2.1bar  
136kg



GB Rubber wheels  
DE Räder  
RU Koneca  
CZ Gumové kolo  
SK Gumové koleso  
HU Kerék  
RO Roată din cauciuc



**Koło do wózka 3.00-4/2PR** G71014 10

4.00/8.00  
8PR  
3.4bar  
180kg



GB Rubber wheels  
DE Räder  
RU Koneca  
CZ Gumové kolo  
SK Gumové koleso  
HU Kerék  
RO Roată din cauciuc



**Koło do taczki 4.00-8/ opona 8PR (szare)** G71017 1

4.00/8.00  
6PR  
2.1bar  
250kg



GB Rubber wheels  
DE Räder  
RU Koneca  
CZ Gumové kolo  
SK Gumové koleso  
HU Kerék  
RO Roată din cauciuc



**Koło do taczki 4.00-8 6PR/niebieska felga/** G71019 1

4.00/8.00  
4PR  
2.1bar



GB Rubber wheels  
DE Räder  
RU Koneca  
CZ Gumové kolo  
SK Gumové koleso  
HU Kerék  
RO Roată din cauciuc



**Koło do taczki 4.00-8 4PR/bieżnik romb,f.zielona/** G71022 1

3.50/4.00  
PU



GB Rubber wheels  
DE Räder  
RU Koneca  
CZ Gumové kolo  
SK Gumové koleso  
HU Kerék  
RO Roată din cauciuc



**Koło do taczki 4.00-8 pełne Flower/żółte** G71023 5

4.00/8.00  
PU



GB Rubber wheels  
DE Räder  
RU Koneca  
CZ Gumové kolo  
SK Gumové koleso  
HU Kerék  
RO Roată din cauciuc



**Koło do taczki 4.00-8 pełne PU orange/** G71024 5

3.00/4.00  
PU



GB Rubber wheels  
DE Räder  
RU Koneca  
CZ Gumové kolo  
SK Gumové koleso  
HU Kerék  
RO Roată din cauciuc



**Koło do wózka 3.00-4 PU/pełne/** G71025 10

3.50/4.00  
PU



GB Rubber wheels  
DE Räder  
RU Koneca  
CZ Gumové kolo  
SK Gumové koleso  
HU Kerék  
RO Roată din cauciuc



**Koło do wózka 3.50-4 PU/pełne/** G71026 10

4.00/6.00  
PU



GB Rubber wheels  
DE Räder  
RU Koneca  
CZ Gumové kolo  
SK Gumové koleso  
HU Kerék  
RO Roată din cauciuc



**Koło do taczki 4.00-6 pełne PU** G71027 10

3.50/8.00  
PU



GB Rubber wheels  
DE Räder  
RU Koneca  
CZ Gumové kolo  
SK Gumové koleso  
HU Kerék  
RO Roată din cauciuc



**Koło do taczki 3.50-8 pełne PU Flower** G71028 5

3.50/8.00  
2PR  
2.4bar



GB Rubber wheels  
DE Räder  
RU Koneca  
CZ Gumové kolo  
SK Gumové koleso  
HU Kerék  
RO Roată din cauciuc



**Koło do taczki 3.50-8/2PR** G71040 1

3.25/8.00  
2PR  
1.7bar



GB Rubber wheels  
DE Räder  
RU Koneca  
CZ Gumové kolo  
SK Gumové koleso  
HU Kerék  
RO Roată din cauciuc



**Koło do taczki 3.25-8/2PR** G71041 5

3.50/4.00  
4PR 2.07bar



GB Rubber wheels  
DE Räder  
RU Колеса  
CZ Gumové kolo  
SK Gumové koleso  
HU Kerék  
RO Roată din cauciuc



5901477158087

Kod produktu **Koło do wózka 3.50-4 20mm - dł.piasty 70mm (G71102) G71046 10**

4.00/10  
4PR 350kg



GB Rubber wheels  
DE Räder  
RU Колеса  
CZ Gumové kolo  
SK Gumové koleso  
HU Kerék  
RO Roată din cauciuc



5901477158124

Kod produktu **Koło pneumatyczne z dętką do zgrabiarki 4.00-10 G71047 1**

4.00/10  
4PR 350kg



GB Rubber wheels  
DE Räder  
RU Колеса  
CZ Gumové kolo  
SK Gumové koleso  
HU Kerék  
RO Roată din cauciuc



5901477158131

Kod produktu **Koło pneumatyczne z dętką do zgrabiarki 4.00-10 z piastą G71048 1**

4.00/8.00  
TYP A



GB Bearings  
DE die Radlager  
RU Подшипники колес  
CZ Ložiska  
SK Ložiská  
HU Keréksarapág  
RO Rulmenti



5901477120244

Kod produktu **Łożysko do kół 4.00-8 TYP A G71010 500**

4.00/8.00  
2PR



GB Tyres, inner tubes  
DE Reifen, Schläuchen  
RU Шины, камеры  
CZ Pneumatiky, duše  
SK Pneumatiky, duše  
HU Gumiabroncsok  
RO Anvelope



5901477113659

Kod produktu **Opona z dętką 4.80/4.00-8 2PR G71000 20**

4.00/6.00  
2PR



GB Tyres, inner tubes  
DE Reifen, Schläuchen  
RU Шины, камеры  
CZ Pneumatiky, duše  
SK Pneumatiky, duše  
HU Gumiabroncsok  
RO Anvelope



5901477115172

Kod produktu **Opona z dętką 4.00-6/2PR G71009 20**

4.00/8.00  
6PR



GB Tyres, inner tubes  
DE Reifen, Schläuchen  
RU Шины, камеры  
CZ Pneumatiky, duše  
SK Pneumatiky, duše  
HU Gumiabroncsok  
RO Anvelope



5901477129902

Kod produktu **Opona z dętką 4.00-8/6PR G71018 20**

4.00/8.00  
4PR



GB Tyres, inner tubes  
DE Reifen, Schläuchen  
RU Шины, камеры  
CZ Pneumatiky, duše  
SK Pneumatiky, duše  
HU Gumiabroncsok  
RO Anvelope



5901477120299

Kod produktu **Opona z dętką 4.00-8/4PR romb G71020 20**

3.00/4.00  
2PR



GB Tyres, inner tubes  
DE Reifen, Schläuchen  
RU Шины, камеры  
CZ Pneumatiky, duše  
SK Pneumatiky, duše  
HU Gumiabroncsok  
RO Anvelope



5901477126222

Kod produktu **Opona z dętką 3.00-4/2PR G71030 20**

3.50/4.00  
2PR



GB Tyres, inner tubes  
DE Reifen, Schläuchen  
RU Шины, камеры  
CZ Pneumatiky, duše  
SK Pneumatiky, duše  
HU Gumiabroncsok  
RO Anvelope



5901477143335

Kod produktu **Opona z dętką 3.50-4/2PR G71031 15**

4.00/4.00  
2PR



GB Tyres, inner tubes  
DE Reifen, Schläuchen  
RU Шины, камеры  
CZ Pneumatiky, duše  
SK Pneumatiky, duše  
HU Gumiabroncsok  
RO Anvelope



5901477126239

Kod produktu **Opona z dętką 4.00-4/2PR G71032 20**

3.25/8.00  
2PR



GB Tyres, inner tubes  
DE Reifen, Schläuchen  
RU Шины, камеры  
CZ Pneumatiky, duše  
SK Pneumatiky, duše  
HU Gumiabroncsok  
RO Anvelope



5901477134302

Kod produktu **Opona z dętką 3.25-8 2PR G71042 20**



3.50/8.00  
2PR



GB Tyres, inner tubes  
DE Reifen, Schläuchen  
RU Шины, камеры  
CZ Pneumatiky, duše  
SK Pneumatiky, duše  
HU Gumiabroncsok  
RO Anvelope

Kod EAN  
5901477134319

Kod produktu  
G71043 20

**Opona z dętką 3.50-8 2PR**

4.00/8.00  
2PR



GB Tyres, inner tubes  
DE Reifen, Schläuchen  
RU Шины, камеры  
CZ Pneumatiky, duše  
SK Pneumatiky, duše  
HU Gumiabroncsok  
RO Anvelope

Kod EAN  
5901477126703

Kod produktu  
G71035 20

**Opona do taczki 4.00-8 2PR**

4.00/8.00  
4PR



GB Tyres, inner tubes  
DE Reifen, Schläuchen  
RU Шины, камеры  
CZ Pneumatiky, duše  
SK Pneumatiky, duše  
HU Gumiabroncsok  
RO Anvelope

Kod EAN  
5901477126727

Kod produktu  
G71036 20

**Opona do taczki 4.00-8 4PR**

4.00/8.00



GB Tyres, inner tubes  
DE Reifen, Schläuchen  
RU Шины, камеры  
CZ Pneumatiky, duše  
SK Pneumatiky, duše  
HU Gumiabroncsok  
RO Anvelope

Kod EAN  
5901477120220

Kod produktu  
G71007 50

**Dętką 4.00-8**

3.00-4



GB Tyres, inner tubes  
DE Reifen, Schläuchen  
RU Шины, камеры  
CZ Pneumatiky, duše  
SK Pneumatiky, duše  
HU Gumiabroncsok  
RO Anvelope

Kod EAN  
5901477120237

Kod produktu  
G71008 100

**Dętką 3 - 4**

4.00-6



GB Tyres, inner tubes  
DE Reifen, Schläuchen  
RU Шины, камеры  
CZ Pneumatiky, duše  
SK Pneumatiky, duše  
HU Gumiabroncsok  
RO Anvelope

Kod EAN  
5901477120275

Kod produktu  
G71015 50

**Dętką 4.00-6**

3.25-8



GB Tyres, inner tubes  
DE Reifen, Schläuchen  
RU Шины, камеры  
CZ Pneumatiky, duše  
SK Pneumatiky, duše  
HU Gumiabroncsok  
RO Anvelope

Kod EAN  
5901477161902

Kod produktu  
G71033 1

**Dętką 3.25-8**

3.50-8



GB Tyres, inner tubes  
DE Reifen, Schläuchen  
RU Шины, камеры  
CZ Pneumatiky, duše  
SK Pneumatiky, duše  
HU Gumiabroncsok  
RO Anvelope

Kod EAN  
5901477161919

Kod produktu  
G71034 1

**Dętką 3.50-8**



# Silniki elektryczne / Electric Engines



GB Electric engine  
 DE Elektromotor  
 RU Электрический двигатель  
 CZ Elektrický motor  
 SK Elektrický motor  
 HU Elektromos motor  
 RO Motoare electrice

Kod EAN

5901477150913

GB Electric engine  
 DE Elektromotor  
 RU Электрический двигатель  
 CZ Elektrický motor  
 SK Elektrický motor  
 HU Elektromos motor  
 RO Motoare electrice

Kod EAN

5901477150920

Silnik elektryczny 1.5KW/2KM 230V 1 fazowy
 Kod produktu G80360 1

Silnik elektryczny 2.2KW/3KM 230V 1 fazowy
 Kod produktu G80361 1



GB Electric engine  
 DE Elektromotor  
 RU Электрический двигатель  
 CZ Elektrický motor  
 SK Elektrický motor  
 HU Elektromos motor  
 RO Motoare electrice

Kod EAN

5901477150937

GB Pulley wheel  
 DE Riemenscheibe  
 RU Шкив колеса  
 CZ Kladkové kolo  
 SK Kladkové koleso  
 HU Szíjtárcsa kerék  
 RO Roata scripete

Kod EAN

5901477166396

Kod EAN

5901477166389

Kod EAN

5901477166372

#Silnik elektryczny 3KW/4KM 230V 1 fazowy
 Kod produktu G80362 1

Koło pasowe do silnika elektrycznego 1,5KW/2KM
 Kod produktu CG80360A 1

Koło pasowe do silnika elektrycznego 2,2KW/3KM
 Kod produktu CG80361A 1

Koło pasowe do silnika elektrycznego 3KW/4KM
 Kod produktu CG80362A 1



# Silniki spalinowe / Gas Engines



389cc  13KM

 3600obr/min



196cc  7KM

 3600obr/min



GB Gasoline four-stroke engine  
 DE 4-Takt-Verbrennungsmotor  
 RU Бензин четырехтактный двигатель  
 CZ Benzínový motor čtyřtákný  
 SK Benzínový motor štvortákný  
 HU Vízszintes tengelyű motor  
 RO Motor pe benzina

GB Gasoline four-stroke engine  
 DE 4-Takt-Verbrennungsmotor  
 RU Бензин четырехтактный двигатель  
 CZ Benzínový motor čtyřtákný  
 SK Benzínový motor štvortákný  
 HU Vízszintes tengelyű motor  
 RO Motor pe benzina

Kod EAN  
  
 5901477177088

Kod EAN  
  
 5901477129070

 Kod produktu   
 Silnik spalinowy 13HP Loncin G390F 25mm (rozruch manualny) G80249 1

 Kod produktu   
 Silnik spalinowy czterosuwowy 7KM G80249 1

389cc 13KM

3600obr/min



196cc 6.5KM

3600obr/min



GB Gasoline four-stroke engine  
DE 4-Takt-Verbrennungsmotor  
RU Бензин четырехтактный двигатель  
CZ Benzinový motor čtyřtákní  
SK Benzinový motor štvortákný  
HU Vízszintes tengelyű motor  
RO Motor pe benzina

Kod EAN  
5901477129087

#Silnik spalinowy czterosuwowy 13KM G80251 1

GB Gasoline four-stroke engine  
DE 4-Takt-Verbrennungsmotor  
RU Бензин четырехтактный двигатель  
CZ Benzinový motor čtyřtákní  
SK Benzinový motor štvortákný  
HU Vízszintes tengelyű motor  
RO Motor pe benzina

Kod EAN  
5901477153402

Silnik spalinowy 6.5HP czujnik oleju G80252 1

196cc 6.5KM

3600obr/min



196cc 6.5KM

3600obr/min



GB Gasoline four-stroke engine  
DE 4-Takt-Verbrennungsmotor  
RU Бензин четырехтактный двигатель  
CZ Benzinový motor čtyřtákní  
SK Benzinový motor štvortákný  
HU Vízszintes tengelyű motor  
RO Motor pe benzina

Kod EAN  
5901477154218

Silnik spalinowy 6,5HP Loncin 196cc 19mm EURO 5 G80253 1

GB Gasoline four-stroke engine  
DE 4-Takt-Verbrennungsmotor  
RU Бензин четырехтактный двигатель  
CZ Benzinový motor čtyřtákní  
SK Benzinový motor štvortákný  
HU Vízszintes tengelyű motor  
RO Motor pe benzina

Kod EAN  
5901477177071

Silnik spalinowy 6,5HP Loncin 196cc 20mm EURO 5 G80254 1





# Oleje / Oils



**100ml**



GB Two-stroke oil  
DE Zweitaktöl  
RU Масло для двухтактных двигателей  
CZ Dvoutaktní olej  
SK Dvojťaktný olej  
HU Kétütemű motorolaj  
RO Ulei de amestec pentru motoare în 2 timpi

Kod EAN  
5901477121777

Kod produktu   
**Olej do silników dwusuwowych czerwony 100ml G82010 24**

**1L**



GB Two-stroke oil  
DE Zweitaktöl  
RU Масло для двухтактных двигателей  
CZ Dvoutaktní olej  
SK Dvojťaktný olej  
HU Kétütemű motorolaj  
RO Ulei de amestec pentru motoare în 2 timpi

Kod EAN  
5901477121760

Kod produktu   
**Olej do silników dwusuwowych czerwony 1L G82011 12**

**100ml**



GB Two-stroke oil  
DE Zweitaktöl  
RU Масло для двухтактных двигателей  
CZ Dvoutaktní olej  
SK Dvojťaktný olej  
HU Kétütemű motorolaj  
RO Ulei de amestec pentru motoare în 2 timpi

Kod EAN  
5901477171758

Kod produktu   
**Olej do silników dwusuwowych zielony 100ml G82012 24**

**5L**



GB Oil for chain bars and chains  
DE Öl für Führungsschiene und Ketten  
RU Масло для цепи и цепи  
CZ Olej na mazání řetězů  
SK Olej na mazanie reťazi  
HU Láncenkő olaj  
RO Ulei de lanț

Kod EAN  
5901477127625

Kod produktu   
**Olej do smarowania prowadnic i łańcuchów GEKO 5L G82016 4**

**1L**



GB Oil for chain bars and chains  
DE Öl für Führungsschiene und Ketten  
RU Масло для цепи и цепи  
CZ Olej na mazání řetězů  
SK Olej na mazanie reťazi  
HU Láncenkő olaj  
RO Ulei de lanț

Kod EAN  
5901477127618

Kod produktu   
**Olej do smarowania prowadnic i łańcuchów GEKO 1L G82015 12**

**600ml**



GB Oil for four-stroke engines  
DE Öl für Viertaktmotoren  
RU Масло для четырехтактных двигателей  
CZ Olej pro čtyřtákní motory  
SK Olej pre štvortákné motory  
HU Motorolaj 4 ütemű  
RO Ulei pentru motoare in 4 timpi

Kod EAN  
5901477160721

Kod produktu   
**Olej do silników czterosuwowych GEKO 0,6L G82024 16**

**1L**



GB Oil for four-stroke engines  
DE Öl für Viertaktmotoren  
RU Масло для четырехтактных двигателей  
CZ Olej pro čtyřtákní motory  
SK Olej pre štvortákné motory  
HU Motorolaj 4 ütemű  
RO Ulei pentru motoare in 4 timpi

Kod EAN  
5901477127656

Kod produktu   
**Olej do silników czterosuwowych GEKO 1L G82025 15**

# Kanistry / Petrol Cans



5L Steel



GB Canister  
DE Kanister  
RU Канистра  
CZ Kanistr  
SK Kanister  
HU Marmonkanna  
RO Canistră



5901477146565

**Kanister metalowy blaszany 5L**      **G03230**      **8**

10L Steel



GB Canister  
DE Kanister  
RU Канистра  
CZ Kanistr  
SK Kanister  
HU Marmonkanna  
RO Canistră



5901477146541

**Kanister metalowy blaszany 10L**      **G03231**      **5**

20L Steel



GB Canister  
DE Kanister  
RU Канистра  
CZ Kanistr  
SK Kanister  
HU Marmonkanna  
RO Canistră



5901477146558

**Kanister metalowy blaszany 20L**      **G03232**      **4**

Steel



GB Funnel  
DE Trichter  
RU Воронка гибкая  
CZ Nálévka  
SK Lievik  
HU Kétrészes tölcser  
RO Pálnie



5901477147555

**Lejek metalowy do kanistra**      **G03233**      **50**



10L Alu



GB Canister  
DE Kanister  
RU Канистра  
CZ Kanistr  
SK Kanister  
HU Marmonkanna  
RO Canistră



Kod EAN  
5901477173066

**Kanister alumiunowy 10L**      Kod produktu **G03236**      3

10L Alu



GB Canister  
DE Kanister  
RU Канистра  
CZ Kanistr  
SK Kanister  
HU Marmonkanna  
RO Canistră



Kod EAN  
5901477173073

**Kanister alumiunowy 20L**      Kod produktu **G03237**      3

5L PE-HD



GB Canister  
DE Kanister  
RU Канистра  
CZ Kanistr  
SK Kanister  
HU Marmonkanna  
RO Canistră



Kod EAN  
5901477147586

**Kanister plastik 5L + lejek**      Kod produktu **G03240**      12

10L PE-HD



GB Canister  
DE Kanister  
RU Канистра  
CZ Kanistr  
SK Kanister  
HU Marmonkanna  
RO Canistră



Kod EAN  
5901477147562

**Kanister plastik 10L + lejek**      Kod produktu **G03241**      5

20L PE-HD



GB Canister  
DE Kanister  
RU Канистра  
CZ Kanistr  
SK Kanister  
HU Marmonkanna  
RO Canistră



Kod EAN  
5901477147579

**Kanister plastik 20L + lejek**      Kod produktu **G03242**      5



# Grille / Grills



11.6 kW  
Ilość palników: 3 + 1  
piezo



14.5 kW  
Ilość palników: 4 + 1  
piezo



GB Gas BBQ grill  
DE Der Gasgrill  
RU Газовый гриль  
CZ Plynový gril  
SK Plynový gril  
HU Gázgrill  
RO Grătarul cu gaz



Kod EAN  
5901477177149  
Kod produktu G80515 1

GB Gas BBQ grill  
DE Der Gasgrill  
RU Газовый гриль  
CZ Plynový gril  
SK Plynový gril  
HU Gázgrill  
RO Grătarul cu gaz



Kod EAN  
5901477177156  
Kod produktu G80516 1

#Grill gazowy 4 palniki (3+1) 11,6kW

#Grill gazowy 5 palników (4+1) 14,5kW



GB Grill cover  
DE Grillabdeckung  
RU Крышка гриля  
CZ Kryt grilu  
SK Kryt grilu  
HU Grill fedél  
RO Capac gratar



Kod EAN  
5901477177187  
Kod produktu CG80515-0 10

Pokrowiec na grill G80515



GB Grill cover  
DE Grillabdeckung  
RU Крышка гриля  
CZ Kryt grilu  
SK Kryt grilu  
HU Grill fedél  
RO Capac gratar



Kod EAN  
5901477177217  
Kod produktu CG80516-0 10

Pokrowiec na grill G80516

3szt.



GB ?  
DE  
RU  
CZ  
SK  
HU  
RO



Kod EAN  
5901477177200  
Kod produktu CG80515-4 15

Aromatyzery do grilla G80515 (zestaw 3 szt)

4szt.



GB ?  
DE  
RU  
CZ  
SK  
HU  
RO



Kod EAN  
5901477177231  
Kod produktu CG80516-4 15

Aromatyzery do grilla G80516 (zestaw 4 szt)



# Pozostałe / Other Garden Tools



4000 kg

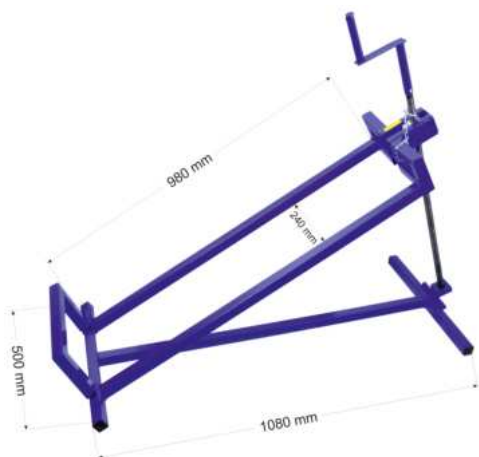

GB Motorcycle elevator  
DE Motorradhebezeug  
RU Мотоциклетный домкрат  
CZ Stojan na motocykl, nosnost  
SK Stojan na motocykel, nosnosť  
HU Motorkerékpár alátámasztó  
RO Elevatoare pentru Motociclete



**Podnośnik ATV kosiarki, quada, traktorka**      **G02183**      **1**



GB Mailbox  
DE Briefkasten  
RU Почтовый ящик  
CZ Schránka na dopisy  
SK Schránka na listy  
HU Levélláda  
RO Cutie poștală



**Skrzynka na listy 300x207x65mm**      **G10920**      **20**



GB Mailbox  
DE Briefkasten  
RU Почтовый ящик  
CZ Schránka na dopisy  
SK Schránka na listy  
HU Levélláda  
RO Cutie poștală



**Skrzynka na listy 320x240x80mm**      **G10921**      **10**



GB Hand-driven maize sheller  
DE Hand bedient mais  
RU Измельчитель кукурузы с ручным приводом  
CZ Loupačka na kukurici  
SK Lúpačku na kukuricu  
HU Kézi hajtású kukorica morzsoló  
RO Batoza curatat porumb stiuleti manuala cu coarba



**Łuszczarka do kukurydzy**      **G73187**      **1**

2mm  
x  
20m



GB Clothesline  
DE Wäscheleine  
RU Веревка для белья  
CZ Šňůra na prádlo  
SK Šňůra na prádlo  
HU Ruhaszárító kötél  
RO Coarda rufe



**Linka stalowa do bielizny 2mm x 20m**      **G73190**      **48**

3mm  
x  
30m



GB Clothesline  
DE Wäscheleine  
RU Веревка для белья  
CZ Šňůra na prádlo  
SK Šňůra na prádlo  
HU Ruhaszárító kötél  
RO Coarda rufe



**Linka stalowa do bielizny 3mm x 30m**      **G73191**      **24**



GB 2in1 barbecue grill brush with scraper  
 DE 2in1 Grillbürste mit Schaber  
 RU Щетка для гриля 2 в 1 со скребком  
 CZ Kartáč na grilování 2v1 se škrabkou  
 SK Keňa na grilovanie 2v1 so škrabkou  
 HU Keňa na grilovanie 2v1 so škrabkou  
 RO 2az1-ben grillkefe kaparóval



Kod EAN  
 5901477177170  
 Kod produktu  
**Szczotka drucziana ze skrobakiem 2w1 – do czyszczenia grilla G80508 90**



GB Barbecue grill accessories set  
 DE Grillzubehör-Set  
 RU Набор аксессуаров для барбекю  
 CZ Sada příslušenství ke grilu  
 SK Sada príslušenstva na grilovanie  
 HU Sada príslušenstva na grilovanie  
 RO Set accesorii gratar gratar



Kod EAN  
 5901477177675  
 Kod produktu  
**Zestaw sztućców do grilla 10el. G80510 12**



GB Mini greenhouse  
 DE Mini-Gewächshaus  
 RU Мини теплица  
 CZ Mini skleník  
 SK Mini skleník  
 HU Mini üvegház  
 RO Mini sera



Kod EAN  
 5901477175749  
 Kod produktu  
**John Gardener Mini szklarnia ogrodowa - balkonowa 5 pólek G73291 1**

38L



GB Garden roller  
 DE Gartenwalze  
 RU Садовый валик  
 CZ Zahradní válec  
 SK Záhradný valec  
 HU Kerti henger  
 RO Tavalug gradina



Kod EAN  
 5901477160592  
 Kod produktu  
**Walec ogrodowy 50cm 38L G73320 1**



GB Exhaust pipe cutter  
 DE Auspuff schneider  
 RU Резец выхлопной трубы  
 CZ Řezačka výfukových trubek  
 SK Rezačka výfukových potrubí  
 HU Kipufogócső-vágó  
 RO Evacuare-tăiere



Kod EAN  
 5901477160318  
 Kod produktu  
**John Gardener Kwasomierz- Miernik pH gleby, temperatury i oświetlenia G73195 35**

60cm



GB Garden machete  
 DE Garten Machete  
 RU Садовый мачете  
 CZ Zahradní mačeta  
 SK Záhradná mačeta  
 HU Kerti machete  
 RO Maceta de gradina



Kod EAN  
 5901477178023  
 Kod produktu  
**John Gardener Maczeta ogrodowa 60cm JG G82955 48**

60cm



GB Garden machete  
 DE Garten Machete  
 RU Садовый мачете  
 CZ Zahradní mačeta  
 SK Záhradná mačeta  
 HU Kerti machete  
 RO Maceta de gradina



Kod EAN  
 5901477178030  
 Kod produktu  
**John Gardener Maczeta ogrodowa z kaburą 60cm JG G82956 48**



# Oświetlenie / Lighting



GB LED lamp with motion detector  
 DE Diodenscheinwerfer mit Bewegungsmelder  
 RU Светодиодный прожектор с датчиком движения  
 CZ LED reflektor se snímačem pohybu  
 SK LED reflektor so snímačom pohybu  
 HU Diódás reflektor mozgásérzékelővel  
 RO Reflektor diodă cu senzor de mișcare



Keltin	Kod produktu	
Naświetlacz LED 30W z czujnikiem ruchu—biała zimna 6500K	K02010	40
Naświetlacz LED 30W z czujnikiem ruchu—biała neutralna 4500K	K02011	40
Naświetlacz LED 30W z czujnikiem ruchu—biała ciepła 2700K	K02012	40

GB LED lamp with motion detector  
 DE Diodenscheinwerfer mit Bewegungsmelder  
 RU Светодиодный прожектор с датчиком движения  
 CZ LED reflektor se snímačem pohybu  
 SK LED reflektor so snímačom pohybu  
 HU Diódás reflektor mozgásérzékelővel  
 RO Reflektor diodă cu senzor de mișcare



Keltin	Kod produktu	
Naświetlacz LED 50W z czujnikiem ruchu—biała zimna 6500K	K02013	20
Naświetlacz LED 50W z czujnikiem ruchu—biała neutralna 4500K	K02014	20
Naświetlacz LED 50W z czujnikiem ruchu—biała ciepła 2700K	K02015	20



GB LED lamp with motion detector  
 DE Diodenscheinwerfer mit Bewegungsmelder  
 RU Светодиодный прожектор с датчиком движения  
 CZ LED reflektor se snímačem pohybu  
 SK LED reflektor so snímačom pohybu  
 HU Diódás reflektor mozgásérzékelővel  
 RO Reflektor diodă cu senzor de mișcare



Keltin	Kod produktu	
Naświetlacz LED 100W z czujnikiem ruchu—biała zimna 6500K	K02016	10
Naświetlacz LED 100W z czujnikiem ruchu—biała neutralna 4500K	K02017	10
Naświetlacz LED 100W z czujnikiem ruchu—biała ciepła 2700K	K02018	10

GB LED lamp with motion detector  
 DE Diodenscheinwerfer mit Bewegungsmelder  
 RU Светодиодный прожектор с датчиком движения  
 CZ LED reflektor se snímačem pohybu  
 SK LED reflektor so snímačom pohybu  
 HU Diódás reflektor mozgásérzékelővel  
 RO Reflektor diodă cu senzor de mișcare



Keltin	Kod produktu	
Lampa solarna z czujnikiem zmierzchu i ruchu 50W	K02025	100

# Myjki ciśnieniowe i akcesoria / Pressure Washers and accessories

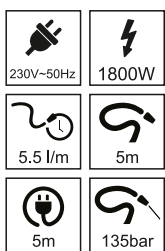

GB High pressure washer  
DE Hochdruckreiniger  
RU Мойка высокого давления  
CZ Vysokotlaké myčky  
SK Vysokotlaková umývačka  
HU Magasnyomású mosó  
RO Spălător de înaltă presiune



John Gardener  
Myjka ciśnieniowa JG 90/135 BAR 1800W  
Kod produktu G81665 1

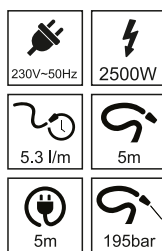

GB High pressure washer  
DE Hochdruckreiniger  
RU Мойка высокого давления  
CZ Vysokotlaké myčky  
SK Vysokotlaková umývačka  
HU Magasnyomású mosó  
RO Spălător de înaltă presiune



John Gardener  
Myjka ciśnieniowa z dodatk. wyposażeniem JG 130/195 BAR 2500W  
Kod produktu G81666 1



1L



GB Pressure washer foam spray nozzle  
DE Hochdruckreiniger schaum sprühdüse  
RU Пенная насадка  
CZ Šampónovací tryska  
SK Šampónovací tryska  
HU Habosító fúvóka  
RO Dispozitiv de spumare cu rezervor

Kod EAN  
5901477141195

Kod produktu  
G73140 20

**Pianownica do myjek ciśnieniowych serii HD z adapterem 1L**

1L



GB Pressure washer foam spray nozzle  
DE Hochdruckreiniger schaum sprühdüse  
RU Пенная насадка  
CZ Šampónovací tryska  
SK Šampónovací tryska  
HU Habosító fúvóka  
RO Dispozitiv de spumare cu rezervor

Kod EAN  
5901477141201

Kod produktu  
G73141 30

**Pianownica do myjek ciśnieniowych serii K2-K7 z adapterem 1L**

1L



GB Pressure washer foam spray nozzle  
DE Hochdruckreiniger schaum sprühdüse  
RU Пенная насадка  
CZ Šampónovací tryska  
SK Šampónovací tryska  
HU Habosító fúvóka  
RO Dispozitiv de spumare cu rezervor

Kod EAN  
5901477141218

Kod produktu  
G73142 40

**Pianownica do myjek ciśnieniowych serii K**

1L



GB Pressure washer foam spray nozzle  
DE Hochdruckreiniger schaum sprühdüse  
RU Пенная насадка  
CZ Šampónovací tryska  
SK Šampónovací tryska  
HU Habosító fúvóka  
RO Dispozitiv de spumare cu rezervor

Kod EAN  
5901477141225

Kod produktu  
G73143 40

**Pianownica do myjek ciśnieniowych Hobby**



GB Strainer  
DE Sieb  
RU Стяжка  
CZ Sedník  
SK Cedidlo  
HU Szűrő  
RO Strecurătoare

Kod EAN  
5901477141256

Kod produktu  
G73144 250

**Sitko do pianownic profesjonalnych**



GB Universal brush  
DE Universalbürste  
RU Универсальная щетка  
CZ Univerzální kartáč  
SK Univerzálna kefa  
HU Univerzális kefe  
RO Perie universală

Kod EAN  
5901477140037

Kod produktu  
G81620 30

**Szczotka uniwersalna do myjki ciśnieniowej**



GB Rotary brush  
DE Drehbürste  
RU Вращающаяся щетка  
CZ Rotační kartáč  
SK Rotačná kefa  
HU Forgó kefe  
RO Pensulă rotativă

Kod EAN  
5901477140044

Kod produktu  
G81621 20

**Szczotka rotacyjna do myjki ciśnieniowej**



GB Nozzle  
DE Düse  
RU Сопло  
CZ Tryska  
SK Tryska  
HU Fúvóka  
RO Duză

Kod EAN  
5901477140051

Kod produktu  
G81622 1

**Dysza turbo do myjki ciśnieniowej**



GB Patio cleaner  
DE Flächenreiniger  
RU Насадки для мойки плоских  
CZ Čistič teras  
SK Čistič terás  
HU Felület tisztító  
RO Curățător de terase

Kod EAN  
5901477140068

Kod produktu  
G81623 25

**Patio Cleaner do myjki ciśnieniowej**



GB Reduction  
DE Reduzierung  
RU Сокращение  
CZ Redukce  
SK Redukcia  
HU Csökkentés  
RO Reducere

Kod EAN  
5901477141232

Kod produktu  
G73104 50

**Adapter do podłączenia akcesoriów z serii K do Myjek HD/HDS**



GB Nozzle  
DE Düse  
RU Сопло  
CZ Tryska  
SK Tryska  
HU Fúvóka  
RO Duză

Kod EAN  
5901477141140

Kod produktu  
G73106 100

**Dysza trójstopniowa przestawna do myjki z gwintem 1/4"**



GB Nozzle  
DE Düse  
RU Сопло  
CZ Tryska  
SK Tryska  
HU Fúvóka  
RO Duză

Kod EAN  
5901477141133

Kod produktu  
G73107 500

**Dysza wody do myjek ciśnieniowych serii HD/HDS**

GB Nozzle  
DE Düse  
RU Сопло  
CZ Tryska  
SK Tryska  
HU Fúvóka  
RO Duza



Kod EAN  
5901477141126

**Dysza wody+ nakrętka do myjek ciśnieniowych serii HD/HDS** G73108 100

GB Nozzle  
DE Düse  
RU Сопло  
CZ Tryska  
SK Tryska  
HU Fúvóka  
RO Duza



Kod EAN  
5901477141119

**Kompletny zestaw naprawczy turbodyszy myjek ciśnieniowych** G73109 50

GB Nozzle  
DE Düse  
RU Сопло  
CZ Tryska  
SK Tryska  
HU Fúvóka  
RO Duza



Kod EAN  
5901477141089

**Obudowa dyszy rotacyjnej serii K** G73110 150

GB Lance rotating  
DE Lanze drehend  
RU Копье вращающееся  
CZ Trubice s rotující tryskou  
SK Trubica s rotujúcou tryskou  
HU Lándzsa forgó  
RO Lance pentru pistol



Kod EAN  
5901477141065

**Dysza rotacyjna turbodysza** G73112 100

GB Lance rotating  
DE Lanze drehend  
RU Копье вращающееся  
CZ Trubice s rotující tryskou  
SK Trubica s rotujúcou tryskou  
HU Lándzsa forgó  
RO Lance pentru pistol



Kod EAN  
5901477141058

**Dysza rotacyjna turbodysza do Karcher K2-K6** G73113 50

GB Lance rotating  
DE Lanze drehend  
RU Копье вращающееся  
CZ Trubice s rotující tryskou  
SK Trubica s rotujúcou tryskou  
HU Lándzsa forgó  
RO Lance pentru pistol

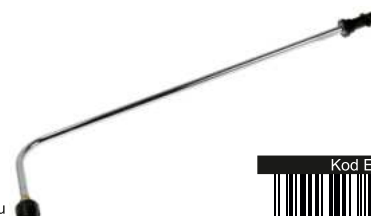

Kod EAN  
5901477141041

**Lanca kątowa do podwozi myjki Karcher K2-K7** G73114 50

GB Pressure cleaning gun  
DE Spritzlanze für Rückenspritzgerät  
RU Профессиональная насадка к опрыскивателю  
CZ Tlakové pistole  
SK Tlakové pištole  
HU Magasnyomású pisztoly  
RO Pistol pentru aparat de spalat cu presiune



Kod EAN  
5901477141034

**Profesjonalna lanca do myjki wysokociśnieniowej M22 345 BAR** G73115 10

GB High pressure washer gun  
DE Hochdruckpistole  
RU Пистолет высокого давления  
CZ Vysokotlaká ostříkovač  
SK Vysokotlakové ostrekovač  
HU Nagynyomású mosó pisztoly  
RO Pistol inalta presiune



Kod EAN  
5901477141027

**Pistolet do myjki wysokociśnieniowej 345 BAR** G73116 25

GB High pressure washer gun  
DE Hochdruckpistole  
RU Пистолет высокого давления  
CZ Vysokotlaká ostříkovač  
SK Vysokotlakové ostrekovač  
HU Nagynyomású mosó pisztoly  
RO Pistol inalta presiune



Kod EAN  
5901477141010

**Pistolet do myjki wysokociśnieniowej 280 BAR** G73117 20

GB Pressure cleaning gun  
DE Spritzlanze für Rückenspritzgerät  
RU Профессиональная насадка к опрыскивателю  
CZ Tlakové pistole  
SK Tlakové pištole  
HU Magasnyomású pisztoly  
RO Pistol pentru aparat de spalat cu presiune



Kod EAN  
5901477126246

**Profesjonalna lanca do myjki wysokociśnieniowej M22 280BAR** G73118 20

GB Pressure cleaning gun  
DE Spritzlanze für Rückenspritzgerät  
RU Профессиональная насадка к опрыскивателю  
CZ Tlakové pistole  
SK Tlakové pištole  
HU Magasnyomású pisztoly  
RO Pistol pentru aparat de spalat cu presiune



Kod EAN  
5901477120961

**Lanca do myjki ciśnieniowej metal złącze 150 BAR** G73119 25

GB Pressure cleaning gun  
DE Spritzlanze für Rückenspritzgerät  
RU Профессиональная насадка к опрыскивателю  
CZ Tlakové pistole  
SK Tlakové pištole  
HU Magasnyomású pisztoly  
RO Pistol pentru aparat de spalat cu presiune



Kod EAN  
5901477117831

**Lanca do myjki wysokociśnieniowej gwint 14mm** G73120 25



**5m**



GB High pressure cleaning hose  
DE Schlange für Rückenspritzgerät  
RU Шланг высокого давления  
CZ Tlaková hadice pro vysokotlaký čistič  
SK Tlaková hadica pre vysokotlakový čistič  
HU Magasnyomású tömlő magasnyomású mosóhoz  
RO Furtun de inalta presiune pentru

Kod EAN  
5901477117848

Kod produktu  
G73121 25

**Wąż do myjki wysokociśnieniowej 5m**

**10m**



GB High pressure cleaning hose  
DE Schlange für Rückenspritzgerät  
RU Шланг высокого давления  
CZ Tlaková hadice pro vysokotlaký čistič  
SK Tlaková hadica pre vysokotlakový čistič  
HU Magasnyomású tömlő magasnyomású mosóhoz  
RO Furtun de inalta presiune pentru

Kod EAN  
5901477117855

Kod produktu  
G73122 20

**Wąż do myjki wysokociśnieniowej 10m**

**10m**



GB High pressure cleaning hose  
DE Schlange für Rückenspritzgerät  
RU Шланг высокого давления  
CZ Tlaková hadice pro vysokotlaký čistič  
SK Tlaková hadica pre vysokotlakový čistič  
HU Magasnyomású tömlő magasnyomású mosóhoz  
RO Furtun de inalta presiune pentru

Kod EAN  
5901477141164

Kod produktu  
G73123 5

**Wąż wysokociśnieniowy 10m do myjek serii HD/HDS**

**10m**



GB High pressure cleaning hose  
DE Schlange für Rückenspritzgerät  
RU Шланг высокого давления  
CZ Tlaková hadice pro vysokotlaký čistič  
SK Tlaková hadica pre vysokotlakový čistič  
HU Magasnyomású tömlő magasnyomású mosóhoz  
RO Furtun de inalta presiune pentru

Kod EAN  
5901477141171

Kod produktu  
G73124 20

**Wąż wysokociśnieniowy 10m do myjek serii K**

**15m**



GB High pressure cleaning hose  
DE Schlange für Rückenspritzgerät  
RU Шланг высокого давления  
CZ Tlaková hadice pro vysokotlaký čistič  
SK Tlaková hadica pre vysokotlakový čistič  
HU Magasnyomású tömlő magasnyomású mosóhoz  
RO Furtun de inalta presiune pentru

Kod EAN  
5901477141188

Kod produktu  
G73125 20

**Wąż do czyszczenia kanalizacji 15m dla myjek serii K**



GB Filter  
DE Filter  
RU Фильтр  
CZ Filtr  
SK Filter  
HU Szűrő  
RO Filtru

Kod EAN  
5901477141096

Kod produktu  
G73130 700

**Filtr wody złączka do myjki na kran 3/4" serii K**



GB Filter  
DE Filter  
RU Фильтр  
CZ Filtr  
SK Filter  
HU Szűrő  
RO Filtru

Kod EAN  
5901477141102

Kod produktu  
G73131 175

**Filtr wody do myjek ciśnieniowych 3/4"**



GB Taper reducer  
DE Verlängerungs-nippel  
RU Ниппель  
CZ Vsuвка s kuželovým závitem  
SK Vsuвка s kuželovým závitom  
HU Kúpos menet  
RO Reductie

Kod EAN  
5901477143076

Kod produktu  
G73132 100

**Nypel 1/4" - 1/4" redukcia złączka do pianownicy**



GB Plug  
DE Stecker  
RU Штепсель  
CZ Svička  
SK Sviečka  
HU Dugó  
RO Dop

Kod EAN  
5901477143083

Kod produktu  
G73133 300

**Wtyk do węży myjek ciśnieniowych serii K dn6**



GB Plug  
DE Stecker  
RU Штепсель  
CZ Svička  
SK Sviečka  
HU Dugó  
RO Dop

Kod EAN  
5901477143090

Kod produktu  
G73134 1

**Wtyk do węży myjek ciśnieniowych Nilfisk ST dn6**



GB Reduction  
DE Reduzierung  
RU Сокращение  
CZ Redukce  
SK Redukcia  
HU Csökkentés  
RO Reducere

Kod EAN  
5901477143052

Kod produktu  
G73135 150

**Redukcja Bayonet do myjek ciśnieniowych serii K 1/4"**



GB Reduction  
DE Reduzierung  
RU Сокращение  
CZ Redukce  
SK Redukcia  
HU Csökkentés  
RO Reducere

Kod EAN  
5901477143069

Kod produktu  
G73136 1

**Redukcja Bayonet do myjek ciśnieniowych serii K 1/4" mosiądz**

# Sprzęt i akcesoria turystyczne / Tourist Equipment & Accessories



Kombinerki 3w1 (Płaskie, Standardowe, Przecinak do drutu)  
 Śrubokręt Philips  
 Śrubokręt płaski 3mm  
 Śrubokręt płaski 4mm  
 Ostrze gładkie  
 Otwieracz do puszek  
 Otwieracz do butelek + wkrętak płaski  
 Nóż ząbkowany  
 Piłnik  
 Mechanizm sprężynowy kombinerki  
 Aluminiowa rękojeść  
 Nylonowe etui



GB Multi function tool  
 DE Klappmesser  
 RU Нож складной  
 CZ Kapesní nůž  
 SK Vreckový nôž  
 HU Zsebkés  
 RO Briceag

Kod EAN



5901477150326

**Narzędzie wielofunkcyjne-multitool 15-funkcyjny** G02410 12

Kombinerki 3w1 (Płaskie, Standardowe, Przecinak do drutu)  
 Karabinczyk  
 Śrubokręt Philips  
 Ostrze gładkie  
 Otwieracz do puszek z małym ząbkowanym nożykiem  
 Mechanizm sprężynowy kombinerki  
 Nylonowe etui



GB Multi function tool  
 DE Klappmesser  
 RU Нож складной  
 CZ Kapesní nůž  
 SK Vreckový nôž  
 HU Zsebkés  
 RO Briceag

Kod EAN

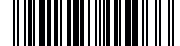

5901477150333

**Narzędzie wielofunkcyjne-multitool 9-funkcyjny** G02411 12

Kombinerki 3w1 (Płaskie, Standardowe, Przecinak do drutu)  
 Piłnik do metalu / drewna + śrubokręt płaski 6mm  
 Śrubokręt płaski 3mm  
 Śrubokręt Philips  
 Ostrze gładkie  
 Piłka do drewna  
 Linijka (2 calowa)  
 Otwieracz do butelek  
 Otwieracz do puszek + śrubokręt płaski 5mm  
 Mechanizm sprężynowy kombinerki  
 Narzędzia ze stali nierdzewnej  
 Rękojeść z kompozytu i stali  
 Nylonowe etui



GB Multi function tool  
 DE Klappmesser  
 RU Нож складной  
 CZ Kapesní nůž  
 SK Vreckový nôž  
 HU Zsebkés  
 RO Briceag

Kod EAN



5901477150357

**Narzędzie wielofunkcyjne-multitool 15-funkcyjny typ. zewnętrzny** G02413 12

Kombinerki 3w1 (Płaskie, Standardowe, Przecinak do drutu)  
 Bity: PH3, PH2, PH1, SL7, SL5, SL3, H5, H4, H3  
 Adapter do bitów  
 Piłnik do drewna/metalu + śrubokręt płaski 6mm  
 Ostrze gładkie  
 Ostrze ząbkowane  
 Szpikulec / sztydio  
 Śrubokręt Philips  
 Śrubokręt płaski 3mm  
 Śrubokręt płaski 4mm  
 Otwieracz do butelek  
 Otwieracz do puszek  
 Mechanizm sprężynowy kombinerki  
 Narzędzia ze stali nierdzewnej  
 Aluminiowa rękojeść  
 Nylonowe etui



GB Multi function tool  
 DE Klappmesser  
 RU Нож складной  
 CZ Kapesní nůž  
 SK Vreckový nôž  
 HU Zsebkés  
 RO Briceag

Kod EAN



5901477150364

**Narzędzie wielofunkcyjne-multitool 20-funkcyjny z bitami** G02414 12





GB Multifunctional shovel  
 DE Kombi-faltschaufel  
 RU Многофункциональная лопата  
 CZ Lopatka víceúčelová  
 SK Lopatka viacúčelová  
 HU Többfunkciós ásó  
 RO Lopata multifunctionala



**Saperka - narzędzie wielofunkcyjne**      Kod produktu **G02420**      **30**



GB Led neck light  
 DE LED-Nackenlicht  
 RU Светодиодный фонарь на шею  
 CZ LED světla na krk  
 SK Led svetlo na krk  
 HU LED nyaki lámpa  
 RO Lumină LED pentru gât



**Wielofunkcyjna lampka LED na szyję**      Kod produktu **G15112**      **80**



GB LED head lamp  
 DE LED kopflampe  
 RU Напольный светодиодный фонарь  
 CZ LED montážní lampa - čelovka  
 SK LED montážna lampa - čelovka  
 HU LED fejlámpa  
 RO Lampa cu LED



**Lampa czolowa CREE XM-L T6 LED 1000lm**      Kod produktu **G15115**      **50**



GB LED front bike light  
 DE Fahrrad Frontscheinwerfer LED  
 RU Светодиодный фонарик для велосипеда  
 CZ Přední světla LED na kolo  
 SK Predné svetla LED na bicykel  
 HU LED-es első kerékpár lámpa  
 RO Lanterna pt. bicicleta LED



**Latarka rowerowa CREE 10W 800lm LED + uchwyt**      Kod produktu **G15120**      **50**



GB Tourist shower  
 DE Touristendusche  
 RU Туристический душ  
 CZ Turistická sprcha  
 SK Turistická sprcha  
 HU Turisztikai zuhany  
 RO Duș turistic



**Prysznic turystyczny 20L (solarny)**      Kod produktu **K00400**      **50**



GB Tourist shower  
 DE Touristendusche  
 RU Туристический душ  
 CZ Turistická sprcha  
 SK Turistická sprcha  
 HU Turisztikai zuhany  
 RO Duș turistic



**Prysznic turystyczny 40L (solarny)**      Kod produktu **K00401**      **25**



GB Tourist gas stove  
 DE Touristischer Gashernd  
 RU Туристическая газовая плита  
 CZ Turistický plynový sporák  
 SK Turistický plynový sporák  
 HU Turisztikai gáztűzhely  
 RO Aragaz turistic



**Kuchenka turystyczna na kartusze**      Kod produktu **G80517**      **12**



GB Tourist gas stove  
 DE Touristischer Gashernd  
 RU Туристическая газовая плита  
 CZ Turistický plynový sporák  
 SK Turistický plynový sporák  
 HU Turisztikai gáztűzhely  
 RO Aragaz turistic



**Kuchenka turystyczna mini na naboje gazowe**      Kod produktu **G80518**      **48**



GB Tourist gas stove  
 DE Touristischer Gashernd  
 RU Туристическая газовая плита  
 CZ Turistický plynový sporák  
 SK Turistický plynový sporák  
 HU Turisztikai gáztűzhely  
 RO Aragaz turistic



**Kuchenka turystyczna gazowa+grill**      Kod produktu **G80521**      **30**



GB Tourist gas stove  
 DE Touristischer Gashernd  
 RU Туристическая газовая плита  
 CZ Turistický plynový sporák  
 SK Turistický plynový sporák  
 HU Turisztikai gáztűzhely  
 RO Aragaz turistic



**Kuchenka turystyczna gazowa z zaworem**      Kod produktu **G80522**      **6**



GB Grill  
DE Grill  
RU Гриль  
CZ Gril  
SK Gril  
HU Rostély  
RO Grătar



**Nakładka Grillowa do kuchenki turystycznej** Kod produktu **G80523** 12



GB Butan Gas Cartridge  
DE Butangaskartusche  
RU Бутановый газовый баллончик  
CZ Butanová plynová kazeta  
SK Butánová plynová kazeta  
HU Bután gázpatron  
RO Cartuș cu gaz butan



**Nabój gazowy 227g** Kod produktu **G20076** 28



GB Butan Gas Cartridge  
DE Butangaskartusche  
RU Бутановый газовый баллончик  
CZ Butanová plynová kazeta  
SK Butánová plynová kazeta  
HU Bután gázpatron  
RO Cartuș cu gaz butan



**Kartusz propan-butan 190g** Kod produktu **G20075** 4



GB Cooler box  
DE Kühlbox  
RU Охладитель коробка  
CZ Autochladnička  
SK Autochladnička  
HU Elektromos hűtőtáska  
RO Geanta frigorifaca



**Lodówka turystyczna 12V/230V 26L** Kod produktu **G80500** 1



GB Cooler box  
DE Kühlbox  
RU Охладитель коробка  
CZ Autochladnička  
SK Autochladnička  
HU Elektromos hűtőtáska  
RO Geanta frigorifaca



**Lodówka turystyczna 12V/230V 32L** Kod produktu **G80501** 1



GB Cooler box  
DE Kühlbox  
RU Охладитель коробка  
CZ Autochladnička  
SK Autochladnička  
HU Elektromos hűtőtáska  
RO Geanta frigorifaca



**Lodówka turystyczna 12V/230V 50L na kołach** Kod produktu **G80504** 1



GB Cooler box  
DE Kühlbox  
RU Охладитель коробка  
CZ Autochladnička  
SK Autochladnička  
HU Elektromos hűtőtáska  
RO Geanta frigorifaca



**Lodówka turystyczna 12V/230V 26L LCD METER** Kod produktu **G80505** 1



GB Cooler box  
DE Kühlbox  
RU Охладитель коробка  
CZ Autochladnička  
SK Autochladnička  
HU Elektromos hűtőtáska  
RO Geanta frigorifaca



**Lodówka turystyczna 12V/230V 32L LCD METER** Kod produktu **G80507** 1



GB Cable for cooler box  
DE Kabel für kühlbox  
RU Кабель для охладитель коробка  
CZ Kabel do chladiaci box  
SK Kábel do chladiaci box  
HU Kábel elektromos hűtőtáska  
RO Cablu la răcitor



**Przewód zasilający lodówki turystycznej 12V** Kod produktu **G80502** 1

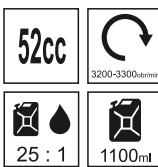

GB Freezer Block Ice Pack  
DE Mini-Kühlblock  
RU Морозильный блок  
CZ Náplň do přenosné chladničky  
SK Náplň do prenosnej chladničky  
HU Mini hűtő blokk  
RO Congelator



**Wkład do lodówki turystycznej 16,5x9x3,5cm** Kod produktu **G80502A** 40

GB Boat engine  
DE Bootsmotor  
RU Лодочный мотор  
CZ Lodní motor  
SK Lodný motor  
HU Csonakmotor  
RO Motor de barca



**Silnik zaburtowy spalinowy łodzi BC520** Kod produktu **G81045** 1





Box / Karton



Blister card / Blister



Polybag with header card / Torebka foliowa z kartonową zawieszka



Polybag / Woreczek foliowy



Header card / Kartonowa zawieszka



Flag tied on card / Zawieszka flaga



Bulk / Luz



Shrink bag / Worek termokurczliwy



Sleeve / Rękaw



Pocket case / Kieszkań typu piórnika

Współpracujemy z Partnerami z całej Polski jak i zagranicą, zapewniając im atrakcyjne warunki handlowe. Dodatkowo oferujemy wsparcie merytoryczne, sprzedażowe oraz marketingowe.

Kooperujemy ze sklepami, hurtowniami na rynku tradycyjnym jak i e-commerce.

We cooperate with Partners from all over Poland and abroad, providing them with attractive trading conditions. Additionally, we offer substantive, sales and marketing support. We cooperate with shops, wholesalers on the traditional market as well as e-commerce.

Z wieloma partnerami współpracujemy od początku naszego istnienia. Przekazujemy naszą wiedzę oraz rozwiązania a także stale się uczymy najnowszych metod komunikacji, które przekazujemy naszym partnerom.

We have been working with many partners since the beginning of our existence. We share our knowledge and solutions and also constantly learn the latest communication methods, which we pass on to our partners.

Jeżeli szukasz stabilnego dostawcę, który:

- jest właścicielem marek, które oferuje
- nieustannie rozwija portfolio produktowe
- oferuje produkty z różnych przedziałów jakościowo cenowych
- udziela atrakcyjne warunki handlowe z którym możesz zbudować
- ekspozycję handlową w swoim lokalu
- zapewnia ciągłość dostaw pozwoli Ci na rozwój Twojej działalności

If you are looking for a stable supplier who:

- is the owner of the brands he offers
- constantly develops his product portfolio
- offers products from different quality and price ranges
- grants attractive trading conditions with which you can build
- a commercial exposure in your premises
- ensures continuity of supplies that will allow you to develop your business

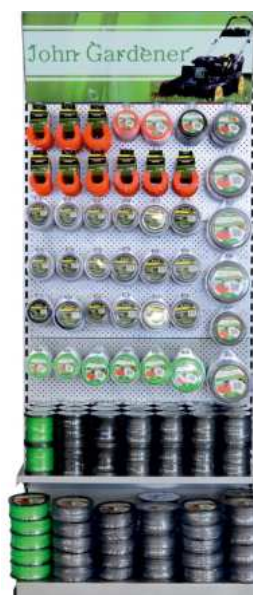

# John Gardener



## Kontakt

GEKO SPÓŁKA Z OGRANICZONĄ ODPOWIEDZIALNOŚCIĄ SPÓŁKA KOMANDYTOWA  
ul. Spacerowa 3  
97-500 Kietlin  
Polska  
(+48) 44 682 40 04  
geko@geko.pl

NIP PL7722420459  
384981078

Spółka zarejestrowana jest przez Sąd Rejonowy dla Łodzi-Śródmieścia w Łodzi, XX Wydział Krajowego Rejestru Sądowego pod numerem KRS 0000849187

## Biuro obsługi klienta

tel.: (+48) 44 682 40 04 | e-mail: geko@geko.pl

## Serwis gwarancyjny i pogwarancyjny GEKO

tel.: (+48) 698-642-358 | e-mail: serwis@geko.pl

